INSTRUCTIONS FOR INSTALLATION AND MAINTENANCE

EVOSTA2
EVOSTA3



INDEX

1. KEY	30
2. GENERAL	30
2.1 Safety	30
2.2 Responsibility	30
2.3 Particular warnings	30
3. PRODUCT DESCRIPTION	31
4. PUMPED LIQUIDS	31
5. APPLICATIONS	32
6. TECHNICAL DATA	32
7. MANAGEMENT	33
7.1 Storage	33
7.2 Transport	33
7.3 Weight	33
8. INSTALLATION	33
8.1 Mechanical installation	34
8.2 User Interface Position	34
8.3 Rotation of the user interface	36
8.4 Non-return valve	37
8.5 Insulating the pump body (only for Evosta3)	37
9. ELECTRICAL CONNECTIONS	38
9.1 Power supply connection	38
10. START	40
10.1 Degassing the pump	41
10.2 Automatic Degassing	41
11. FUNCTIONS	42
11.1 Regulating Modes	42
11.1.1 Regulation with Proportional Differential Pressure	42
11.1.2 Regulation with Constant Differential Pressure	43
11.1.3 Regulation with constant curve	43
12. CONTROL PANEL	44
12.1 Elements on the Display	44
12.2 Graphic Display	44
13. FACTORY SETTINGS	47
14. TYPES OF ALARM	47
15. MAINTENANCE	47
16. DISPOSAL	47
17. DIMENSIONS	48
18. PERFORMANCE CURVES	50

INDEX OF FIGURES

Figure 1: Pumped liquids, warnings and operating conditions	31
Figure 2: Mounting EVOSTA2 or EVOSTA3	34
Figure 3: Assembly position	34
Figure 4: Positions of the user interface	35
Figure 5: Positions of the user interface	36
Figure 6: Changing the position of the user interface	36
Figure 7: Insulating the pump body	37
Figure 8: Venting of the pump	41
Figure 9: Automatic venting of the pump	41
Figure 10: Display	44
Figure 11: Evosta3 Display	45

INDEX OF TABLES

Table 1: Functions	31
Table 2: Technical data	32
Table 3: Maximum head (Hmax) and maximum flow rate (Qmax) of EVOSTA2, EVOSTA3 circulators.....	33
Table 4: Mounting the Evosta3 connector	39
Table 5: Mounting the Evosta2 connector	40
Table 6: Pump operating modes	46
Table 7: Types of Alarm.....	47

1. KEY

The frontispiece shows the version of this document in the form **Vn.x**. This version indicates that the document is valid for all software versions of the device **n.y**. For example: V3.0 is valid for all Sw: 3.y.

In this document the following symbols will be used to avoid situations of danger:



Situation of **general danger**. Failure to respect the instructions that follow may cause harm to persons and property.



Situation of **electric shock hazard**. Failure to respect the instructions that follow may cause a situation of grave risk for personal safety.

2. GENERAL



Read this documentation carefully before installation.

Skilled personnel: Installation must be carried out by competent, skilled personnel in possession of the technical qualifications required by the specific legislation in force. The term skilled personnel means persons whose training, experience and instruction, as well as their knowledge of the respective standards and requirements for accident prevention and working conditions, have been approved by the person in charge of plant safety, authorizing them to perform all the necessary activities, during which they are able to recognize and avoid all dangers. (Definition for technical personnel IEC 364).

The appliance may not be used by children under 8 years old or by persons with reduced physical, sensory or mental capacities, or who lack experience or knowledge, unless they are under supervision or after they have received instructions concerning the safe use of the appliance and the understanding of the dangers involved. Children must not play with the appliance.



Ensure that the product has not suffered any damage during transport or storage. Check that the outer casing is unbroken and in excellent conditions.

2.1 Safety

Use is allowed only if the electric system is in possession of safety precautions in accordance with the regulations in force in the country where the product is installed.

2.2 Responsibility

The Manufacturer does not vouch for correct operation of the machine or answer for any damage that it may cause if it has been tampered with, modified and/or run outside the recommended work range or in contrast with other indications given in this manual.

2.3 Particular warnings



Always switch off the mains power supply before working on the electrical or mechanical part of the system. Wait for the warning lights on the control panel to go out before opening the appliance. The capacitor of the direct current intermediate circuit remains charged with dangerously high voltage even after the mains power has been turned off.

Only firmly cabled mains connections are admissible. The appliance must be earthed (IEC 536 class 1, NEC and other applicable standards).



Mains terminals and motor terminals may still have dangerous voltage when the motor is stopped.



If the power cable is damaged, it must be replaced by the technical assistance service or by qualified personnel, so as to avoid any risk.

3. PRODUCT DESCRIPTION

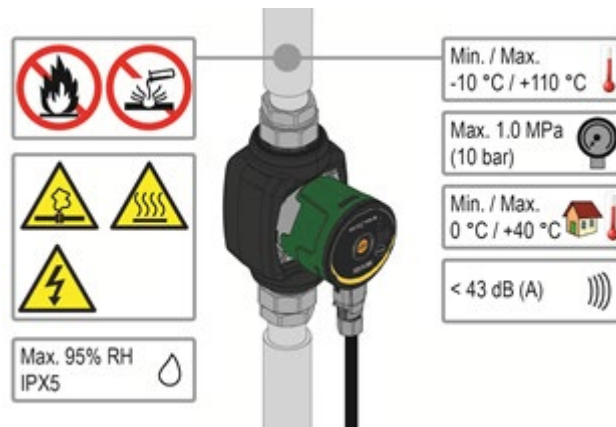

Figure 1: Pumped liquids, warnings and operating conditions

The circulators in the EVOSTA2 and EVOSTA3 series represent a complete range of circulators. These installation and operating instructions describe EVOSTA2 and EVOSTA3 models. The type of model is indicated on the pack and on the identification plate.

The table below shows the EVOSTA2 and EVOSTA3 models with built-in functions and features.

Functions/features	EVOSTA 2	EVOSTA 3
Proportional pressure	•	•
Constant pressure	•	•
Constant curve	•	•
Dry-running protection		•
Automatic degassing		•

Table 1: Functions

4. PUMPED LIQUIDS

Clean, free from solids and mineral oils, not viscous, chemically neutral, close to the properties of water (max. glycol contents 30%)

5. APPLICATIONS

EVOSTA2, EVOSTA3 series circulators allow integrated adjustment of the differential pressure which enables the circulator performance to be adapted to the actual requirements of the system. This determines considerable energy saving, a greater possibility of control of the system, and reduced noise.

EVOSTA2, EVOSTA3 circulators are designed for the circulation of:

- water in heating and conditioning systems.
- water in industrial water circuits.
- domestic water **only for the versions with bronze pump body.**

EVOSTA2, EVOSTA3 circulators are self-protected against:

- Overloads
- Lack of phase
- Excess temperature
- Over-voltage and under-voltage

6. TECHNICAL DATA

Supply voltage	1x230 V(+/-10%), 50/60 Hz
Absorbed power	See electrical data plate
Maximum current	See electrical data plate
Grade of protection	IPX5
Protection class	F
TF Class	TF 110
Motor protector	No external motor protector is needed
Maximum environment temperature	40 °C
Liquid temperature	-10 °C ÷ 110 °C
Flow rate	See Table 3
Head	See Table 3
Maximum working pressure	1.0 Mpa – 10 bar
Minimum working pressure	0.1 Mpa – 1 bar
Lpa [dB(A)]	≤ 43

Table 2: Technical data

Designation index

(example)

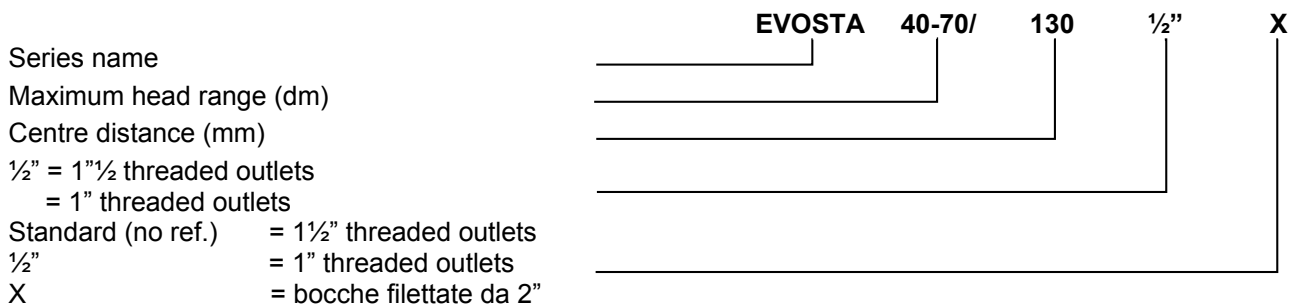

EVOSTA2, EVOSTA3	Hmax [m]	Qmax [m ³ /h]
EVOSTA2 40-70/xxx M230/50-60	6,9	3,6
EVOSTA2 80/xxx M230/50-60	8	4,2
EVOSTA3 40/xxxM230/50-60	4	2,9
EVOSTA3 60/xxx M230/50-60	6	3,6
EVOSTA3 80/xxx M230/50-60	8	4,2

Table 3: Maximum head (Hmax) and maximum flow rate (Qmax) of EVOSTA2, EVOSTA3 circulators

7. MANAGEMENT

7.1 Storage

All the circulators must be stored in a dry covered place, with possibly constant air humidity, free from vibrations and dust. They are supplied in their original pack in which they must remain until the time of installation. If this is not the case, accurately close the suction and delivery mouth.

7.2 Transport

Avoid subjecting the products to needless impacts and collisions. To lift and transport the circulator use lifting devices with the aid of the pallet supplied with it (if contemplated).

7.3 Weight

The adhesive plate on the packaging indicates the total weight of the circulator.

8. INSTALLATION

Carefully follow the advice in this chapter to carry out correct electrical, hydraulic and mechanical installation.



Always switch off the mains power supply before working on the electrical or mechanical part of the system. Wait for the warning lights on the control panel to go out before opening the appliance. The capacitor of the direct current intermediate circuit remains charged with dangerously high voltage even after the mains power has been turned off.

Only firmly cabled mains connections are admissible. The appliance must be earthed (IEC 536 class 1, NEC and other applicable standards).



Ensure that the voltage and frequency on the data plate of the EVOSTA2, EVOSTA3 circulator are the same as those of the power mains.

8.1 Mechanical installation

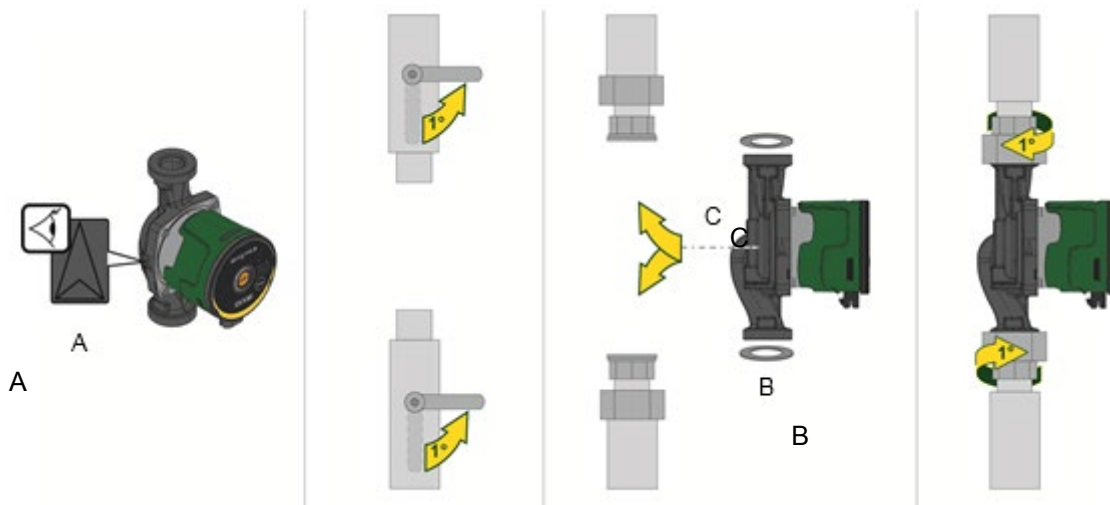

Figure 2: Mounting EVOSTA2 or EVOSTA3

The arrows on the pump housing indicate the flow direction through the pump. See fig. 1, pos. A.

1. Fit the two gaskets when you mount the pump in the pipe. See fig. 1, pos. B.
2. Install the pump with a horizontal motor shaft. See fig. 1, pos. C.
3. Tighten the fittings.

8.2 User Interface Position



Always install the EVOSTA2, EVOSTA3 circulator with the motor shaft in a horizontal position.

Install the electronic control device in a vertical position.

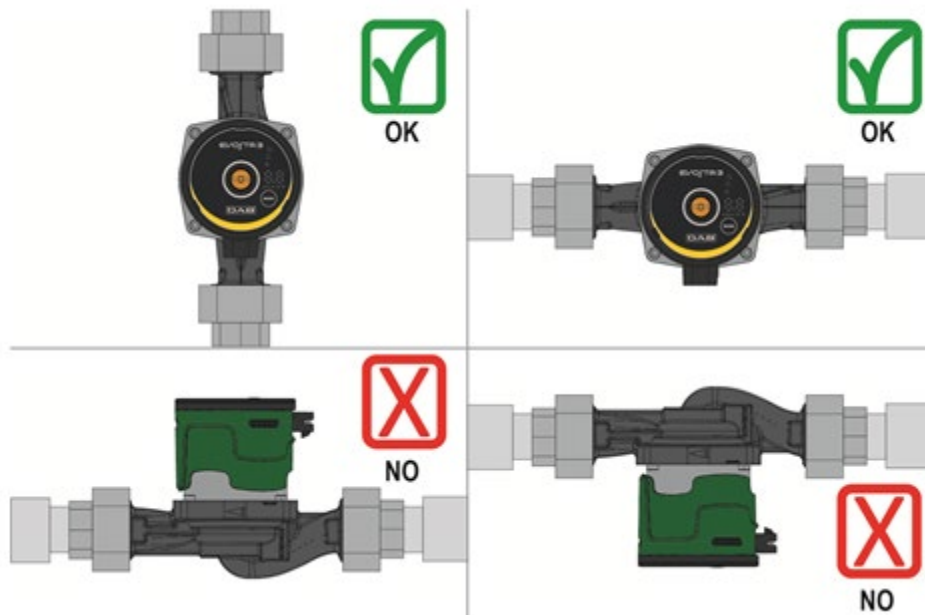

Figure 3: Assembly position

- The circulator may be installed in heating and conditioning systems on either the delivery pipe or the return pipe; the arrow marked on the pump body indicates the direction of flow.
- Install the circulator as far as possible above the minimum boiler level and as far as possible from bends, elbows and junction boxes.

- To facilitate control and maintenance operations, install an interception valve both on the suction pipe and on the delivery pipe.
- Before installing the circulator, accurately flush the system with only water at 80°C. Then drain the system completely to eliminate any harmful substance that may have got into circulation.
- Avoid mixing additives derived from hydrocarbons and aromatic products with the circulating water. It is recommended that the addition of antifreeze, where necessary, should not exceed 30%.
- In the event of heat insulation use the special kit (if provided) and ensure that the condensate draining holes in the motor casing are not closed or partly blocked.
- In the case of maintenance, always use a set of new gaskets.



Never insulate the electronic control device.

8.2.1 Positioning of the user interface in heating and domestic hot water systems

It is possible to position the user interface with the cable facing to the left, to the right, or downwards.

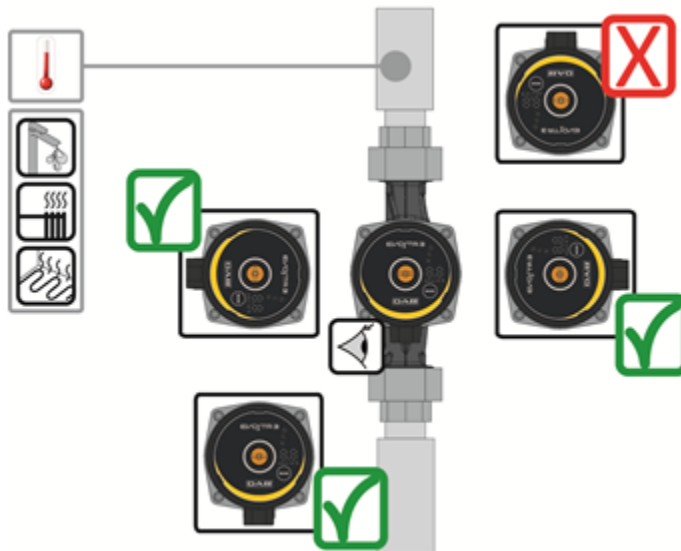

Figure 4: Positions of the user interface

8.2.2 Positioning of the user interface in conditioning and cold water systems

The user interface can be positioned only with the cable facing downwards.

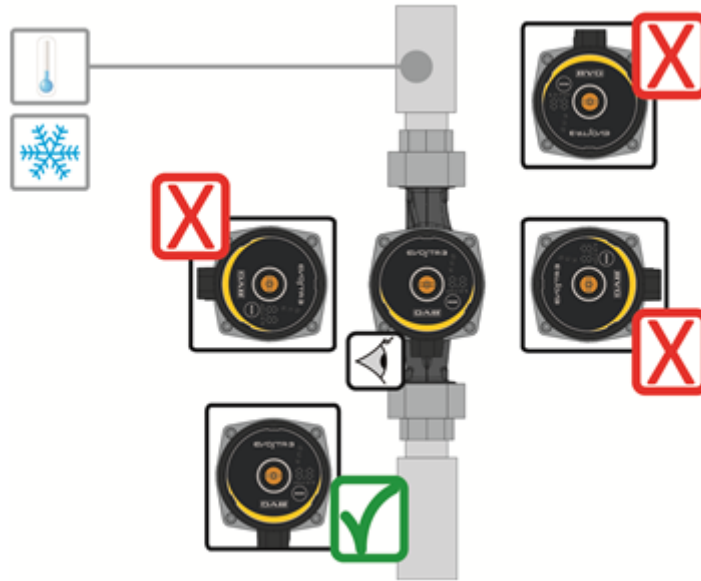

Figure 5: Positions of the user interface

8.3 Rotation of the user interface

If the circulator is installed on pipes in a horizontal position, it will be necessary to rotate the interface with the respective electronic device through 90 degrees in order to maintain the grade of IP protection and to allow the user a more convenient interaction with the graphic interface.



Before rotating the circulator, ensure that it has been completely drained.

To rotate the EVOSTA2, EVOSTA3 circulator, proceed as follows:

1. Remove the 4 fixing screws of the circulator head.
2. Rotate the motor casing with the electronic control device through 90 degrees clockwise or counterclockwise, as necessary.
3. Reassemble and tighten the 4 screws that fix the circulator head.



The electronic control device must always remain in vertical position!

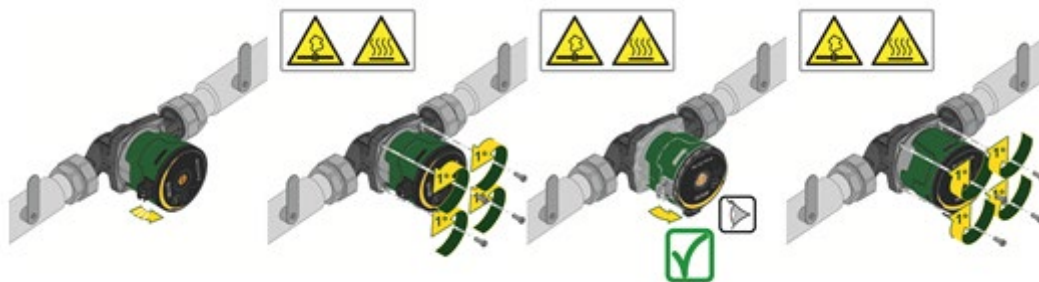

Figure 6: Changing the position of the user interface



ATTENTION
Water at high temperature.
High temperature.



ATTENTION
System under pressure
- Before dismantling the pump, empty the system or close the interception valves on both sides of the pump. The pumped liquid may be at a very high temperature and high pressure.

8.4 Non-return valve

If the system is equipped with a non-return valve, ensure that the minimum pressure of the circulator is always higher than the valve closing pressure.

8.5 Insulating the pump body (only for Evosta3)



Figure 7: Insulating the pump body

It is possible to reduce the loss of heat from the EVOSTA3 pump by insulating the pump body with the insulating shells supplied with the pump. See fig.9



Do not insulate the electronic box and do not cover the control panel

9. ELECTRICAL CONNECTIONS

The electrical connections must be made by expert, qualified personnel.



ATTENTION! ALWAYS RESPECT THE LOCAL SAFETY REGULATIONS.



Always switch off the mains power supply before working on the electrical or mechanical part of the system. Wait for the warning lights on the control panel to go out before opening the appliance. The capacitor of the direct current intermediate circuit remains charged with dangerously high voltage even after the mains power has been turned off.

Only firmly cabled mains connections are admissible. The appliance must be earthed (IEC 536 class 1, NEC and other applicable standards).



THE SYSTEM MUST BE CORRECTLY AND SAFELY EARTHED!



It is advised to install a correctly dimensioned differential switch to protect the system, type: class A with adjustable leakage current, selective.

The automatic differential switch must be marked with the following symbols:

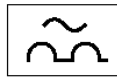

- The circulator does not require any external motor protection.
- Ensure that the supply voltage and frequency are the same as the values indicated on the electrical data plate of the circulator.

9.1 Power supply connection

Before supplying power to the circulator, ensure that the cover of the EVOSTA2, EVOSTA3 control panel is perfectly closed!

EVOSTA3

Phase	1	2	3
Action	Unscrew the cable gland nut and extract the terminal board from the connector, releasing it from the side clips.	Rotate the terminal board through 180°.	Fit nut and connector on the cable. Strip the wires as indicated in the figure. Connect the wires to the terminal board, respecting the phase, neutral and earth
Illustration			
Phase	4	5	
Action	Insert the wired terminal board in the cable gland, securing it with the side clips. Screw on the locking nut.	Connect the wired connector to the pump, securing it with the rear hook.	
Illustration			

Table 4: Mounting the Evosta3 connector

EVOSTA2

Phase	1	2	3
Action	Unscrew the cable gland nut and extract the terminal board from the connector.	Remove the retaining screw.	Fit nut and connector on the cable. Strip the wires as indicated in the figure. Connect the wires to the terminal board, respecting the phase, neutral and earth.
Illustration			
Phase	4	5	
Action	Insert the wired terminal board in the cable gland. Screw on the locking nut.	Connect the wired connector to the pump and tighten the retaining screw.	
Illustration			

Table 5: Mounting the Evosta2 connector

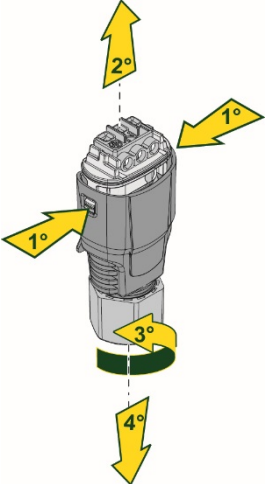
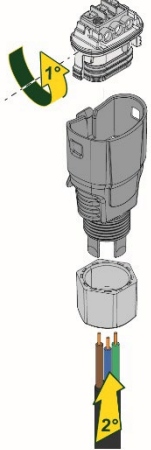
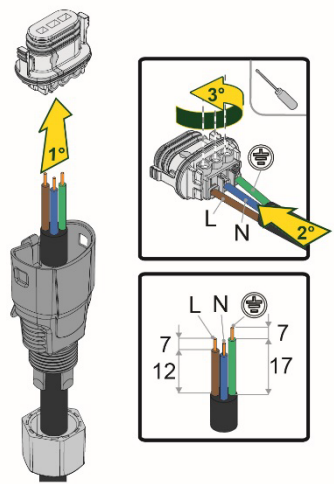
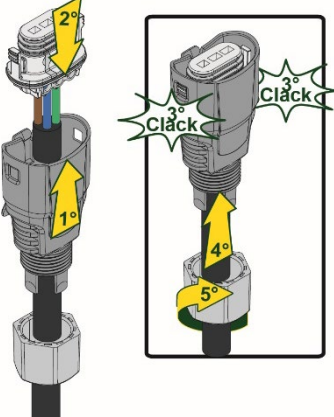
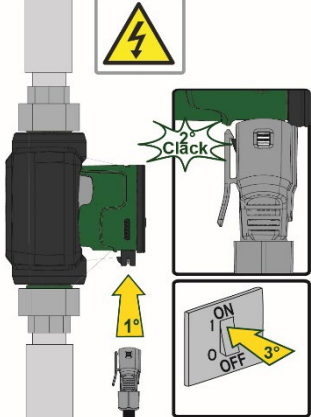
10. START

All the starting operations must be performed with the cover of the EVOSTA2, EVOSTA3 control panel closed.



Start the system only when all the electrical and hydraulic connections have been completed.

Avoid running the circulator when there is no water in the system.



As well as being at a high temperature and pressure, the fluid in the system may also be in the form of steam. **DANGER OF SCALDING!**

It is dangerous to touch the circulator. **DANGER OF SCALDING!**

Once all the electrical and hydraulic connections have been made, fill the system with water and if necessary with glycol (for the maximum glycol percentage see par. 3) and feed the system.

Once the system has been started it is possible to modify the operating modes to adapt better to the plant requirements (see par.12).

10.1 Degassing the pump

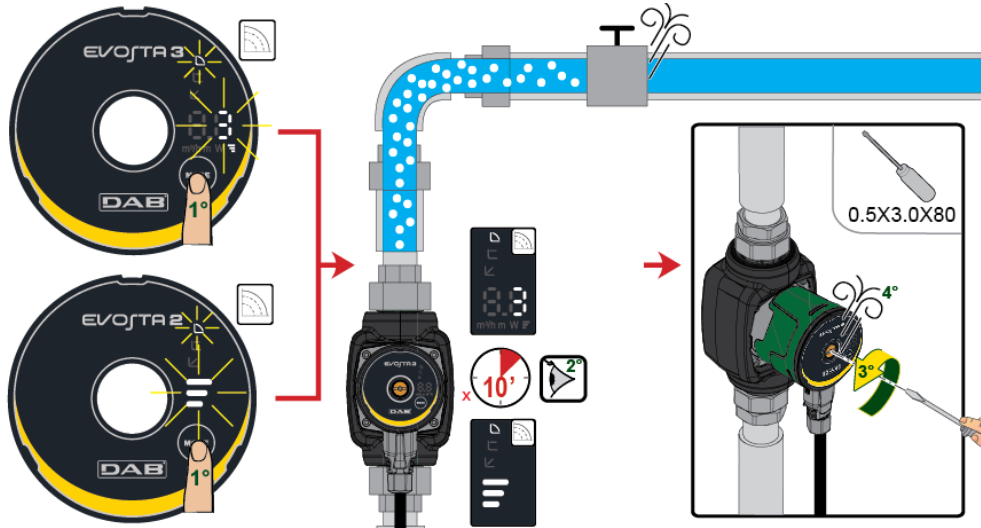

Figure 8: Venting of the pump



Always vent the pump before starting!

The pump must never run when dry.

10.2 Automatic Degassing

Automatic degassing occurs only for the Evosta3 pump. Hold down the Mode key for 3" and the function starts: 1 minute at maximum speed, then it passes to the set mode.

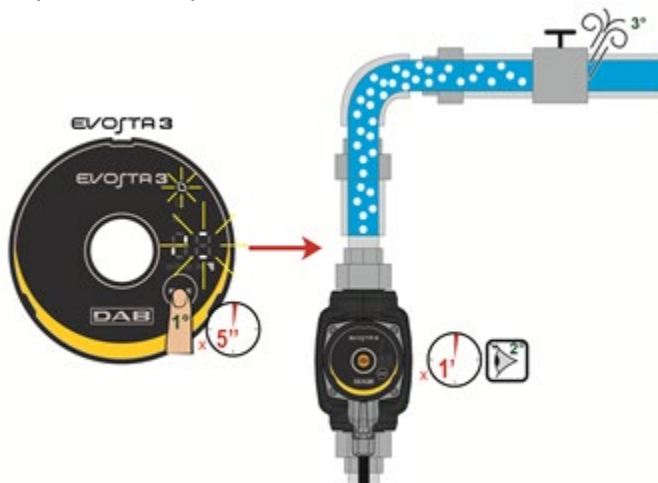

Figure 9: Automatic venting of the pump

11. FUNCTIONS

11.1 Regulating Modes

EVOSTA2, EVOSTA3 circulators allow the following regulating modes depending on plant requirements:

- Proportional differential pressure regulation depending on the flow present in the plant.
- Constant differential pressure regulation.
- Regulation with constant curve.

The regulating mode may be set through the EVOSTA2, EVOSTA3 control panel.

11.1.1 Regulation with Proportional Differential Pressure

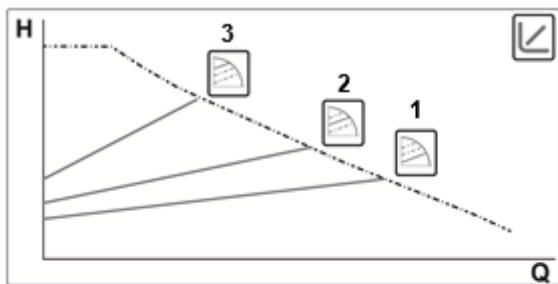

In this regulating mode the differential pressure is reduced or increased as the demand for water decreases or increases.

The Hs set point may be set from the display.



Regulation indicated for:

- Heating and conditioning plants with high load losses
- Plants with secondary differential pressure regulator
- Primary circuits with high load losses
- Domestic water recirculating systems with thermostatic valves on the rising columns

11.1.1.1 Regulation with Proportional Differential Pressure –Advanced Menu

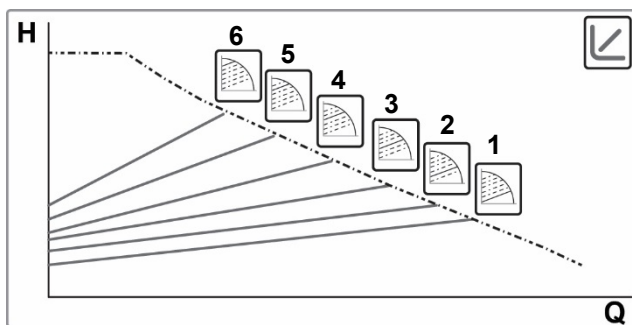

Holding down the Mode key for 20" gives access to the Advanced Menu with the possibility of selecting from 6 curves with proportional differential pressure



11.1.2 Regulation with Constant Differential Pressure

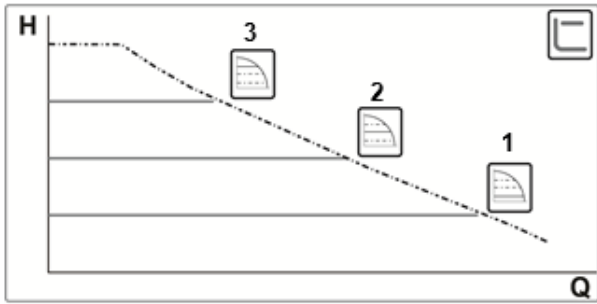

In this regulating mode the differential pressure is kept constant, irrespective of the demand for water, The Hs set point may be set from the display.



Regulation indicated for:

- Heating and conditioning plants with low load losses
- Single-pipe systems with thermostatic valves
- Plants with natural circulation
- Primary circuits with low load losses
- Domestic water recirculating systems with thermostatic valves on the rising columns

11.1.3 Regulation with constant curve

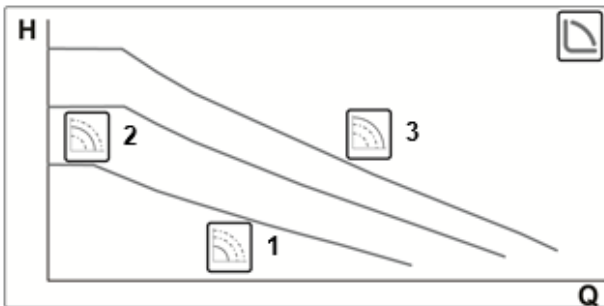

In this regulating mode the circulator works on characteristic curves at a constant speed.



Regulation indicated for heating and conditioning plants with constant flow.

12. CONTROL PANEL

The functions of EVOSTA2, EVOSTA3 circulators can be modified by means of the control panel on the cover of the electronic control device.

12.1 Elements on the Display

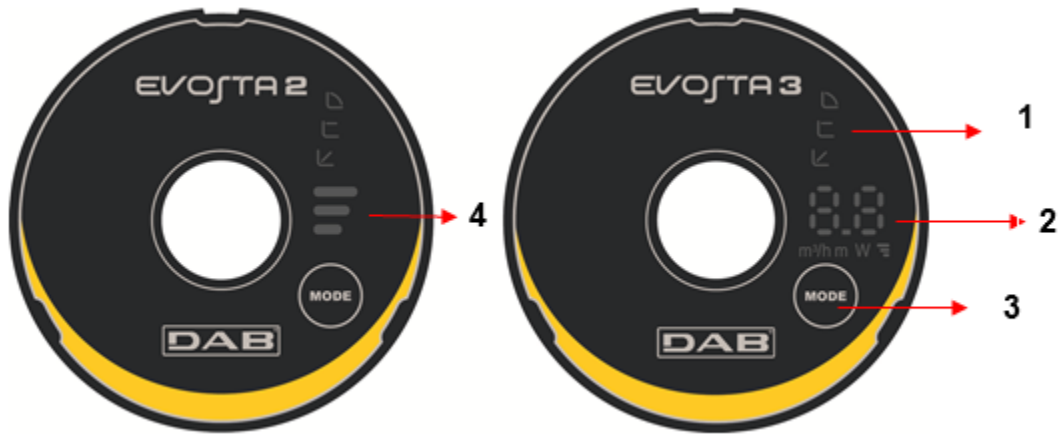



Figure 10: Display

- 1 Luminous segments indicating the type of set curve
- 2 Display showing the instantaneous power absorption in Watt, the flow rate in m³/h, the head in metres and the set curve.
- 3 Key for selecting the pump setting
- 4 Luminous segments indicating the set curve

12.2 Graphic Display

12.2.1 Luminous segments indicating the pump setting

The pump presents nine setting options that can be selected with the  key. The pump settings are indicated by six luminous segments on the display.

12.2.2 Key for selecting the pump setting



Whenever the  key is pressed, the pump setting is changed. A cycle consists of pressing the key ten times.

12.2.3 Display Operation



Figura 11: Evosta3 Display

The Evosta3 circulator has a display that is able to show the following values.

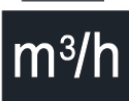
	Height of the selected curve (1-2-3)
	Instantaneous power absorption in Watt
	Instantaneous head in m
	Instantaneous flow rate in m ³ /h

The values are shown in sequence for 3". Once the viewing cycle is ended, the display switches off and only the operating mode LED remains lit.

If the selection key is pressed within 10", the display performs 6 viewing cycles, then goes into stand-by.

If the key is pressed again within 10", the display performs 11 more viewing cycles to allow a greater reading time.

12.2.4 Settings of the pump operating mode

	EVOSTA3	EVOSTA2	
1			Lower curve with proportional pressure, PP1
2			Intermediate curve with proportional pressure, PP2
3			Higher curve with proportional pressure, PP3
4			Lower curve with constant pressure, CP1
5			Intermediate curve with constant pressure, CP2
6			Higher curve with constant pressure, CP3
7			Lower constant curve, I
8			Intermediate constant curve, II
9			Higher constant curve, III

Table 6: Pump operating modes

13. FACTORY SETTINGS

Regulating mode:  = Minimum proportional differential pressure regulation

14. TYPES OF ALARM

No. of curve height blinks	Alarm Description
	EVOSTA2
2 Blinks	TRIP: loss of motor control, may be caused by incorrect parameters, blocked rotor, disconnected phase, disconnected motor
3 Blinks	SHORT CIRCUIT: short circuit on phases or between phase and earth
4 Blinks	OVERRUN: software fault
5 Blinks	SAFETY: safety module error, may be caused by a sudden overcurrent or other hardware faults of the board
Alarm Code	EVOSTA3
E1	DRY RUN
E2	TRIP: loss of motor control, may be caused by incorrect parameters, blocked rotor, disconnected phase, disconnected motor
E3	SHORT CIRCUIT: short circuit on phases or between phase and earth
E4	OVERRUN: software fault
E5	SAFETY: safety module error, may be caused by a sudden overcurrent or other hardware faults of the board

Table 7: Types of Alarm

15. MAINTENANCE



Cleaning and maintenance activities must not be carried out by children (under 8 years of age) without supervision by a qualified adult. Before starting any work on the system, before starting to look for faults it is necessary to disconnect the power supply to the pump (take the plug out of the socket) and read the use and maintenance instructions.

16. DISPOSAL



This product or its parts must be disposed of in an environment-friendly manner and in compliance with the local regulations concerning the environment; use public or private local waste collection systems.

INFORMATION

Frequently asked questions (faq) on the ecodesign directive 2009/125/ec establishing a framework for the setting of ecodesign requirements for energy-related products and its implementing regulations: http://ec.europa.eu/enterprise/policies/sustainable-business/documents/ecodesign/guidance/files/20110429_faq_en.pdf

Guidelines accompanying commission regulations implementing the ecodesign directive: http://ec.europa.eu/energy/efficiency/ecodesign/legislation_en.htm - see "circulators"

17. DIMENSIONS

Evosta 2 Dimensions

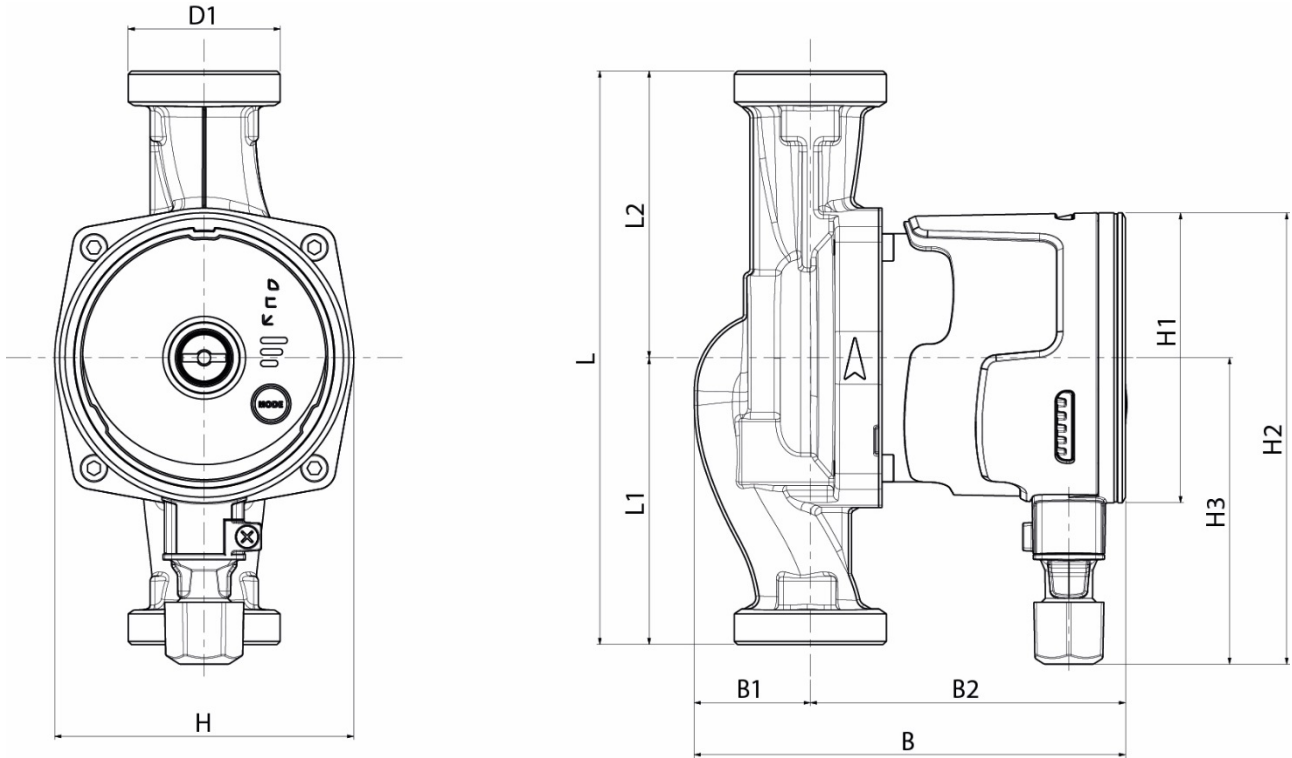

Mod.	L	L1	L2	B	B1	B2	D1	H	H1	H2	H3
EVOSTA2 40-70/80/130 (1/2") M230/50-60	130	65	65	135	36	99	1"	94	Ø91	142	96
EVOSTA2 40-70/80/130 (1") M230/50-60	130	65	65	135	26.5	109	1"1/2	91	Ø91	142	96
EVOSTA2 40-70/80/180 (1") M230/50-60	180	90	90	135	36	99	1"1/2	94	Ø91	142	96
EVOSTA2 40-70/80/180 (1"1/4) M230/50-60	180	90	90	135	36	99	2"	94	Ø91	142	96

Evosta 3 Dimensions

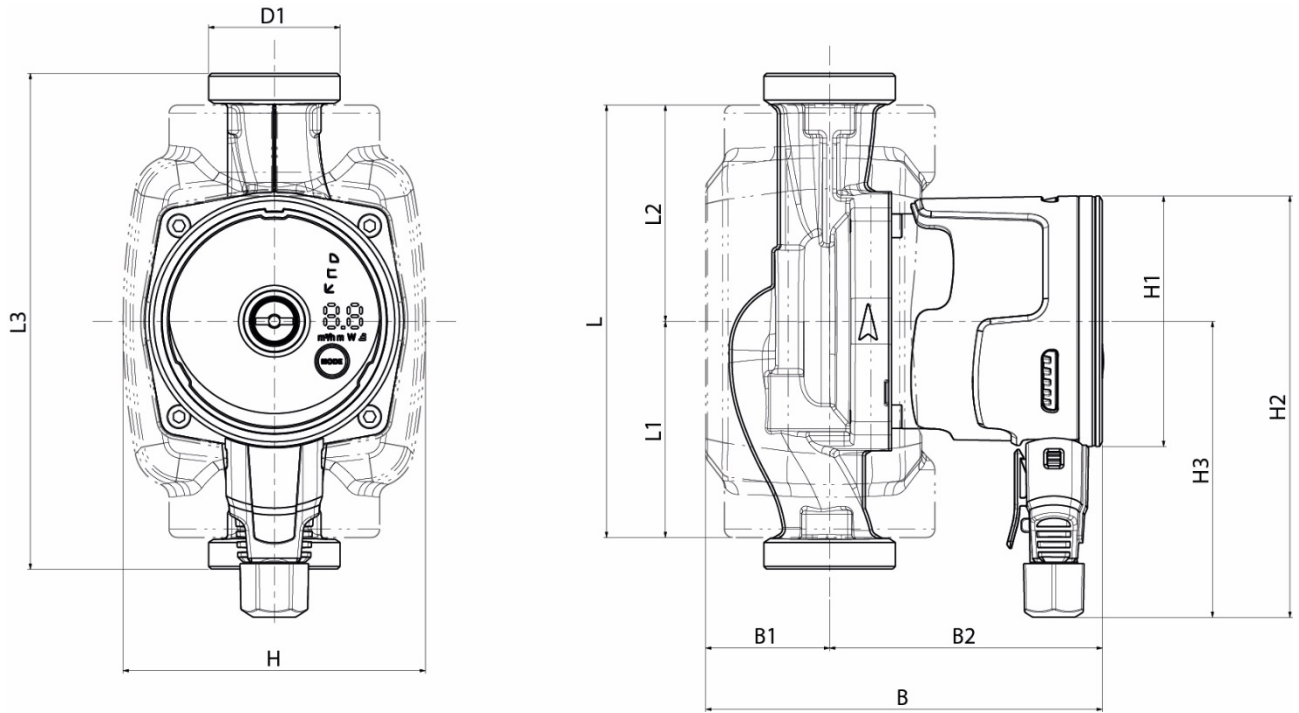

Mod.	L	L1	L2	L3	B	B1	B2	D1	H	H1	H2	H3
EVOSTA3 40/60/80/130 (1/2") M230/50-60	157	78,5	65	130	144	45	99	1"	110	Ø91	153	107,5
EVOSTA3 40/60/80/130 (1") M230/50-60	157	78,5	65	130	144	26.5	109	1"1/2	91	Ø91	153	107,5
EVOSTA3 40/60/80/180 (1") M230/50-60	157	78,5	90	180	144	45	99	1"1/2	110	Ø91	153	107,5
EVOSTA3 40/60/80/180 (1"1/4) M230/50-60	157	78,5	90	180	144	45	99	2"	110	Ø91	153	107,5

18. PERFORMANCE CURVES

EVOSTA2 40-70/XXX

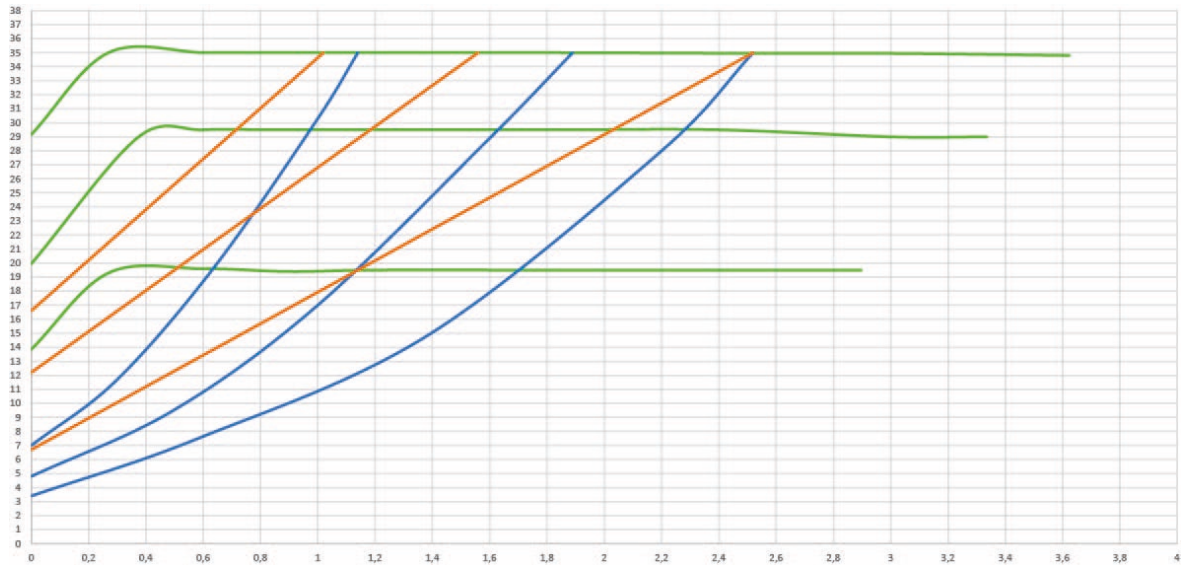
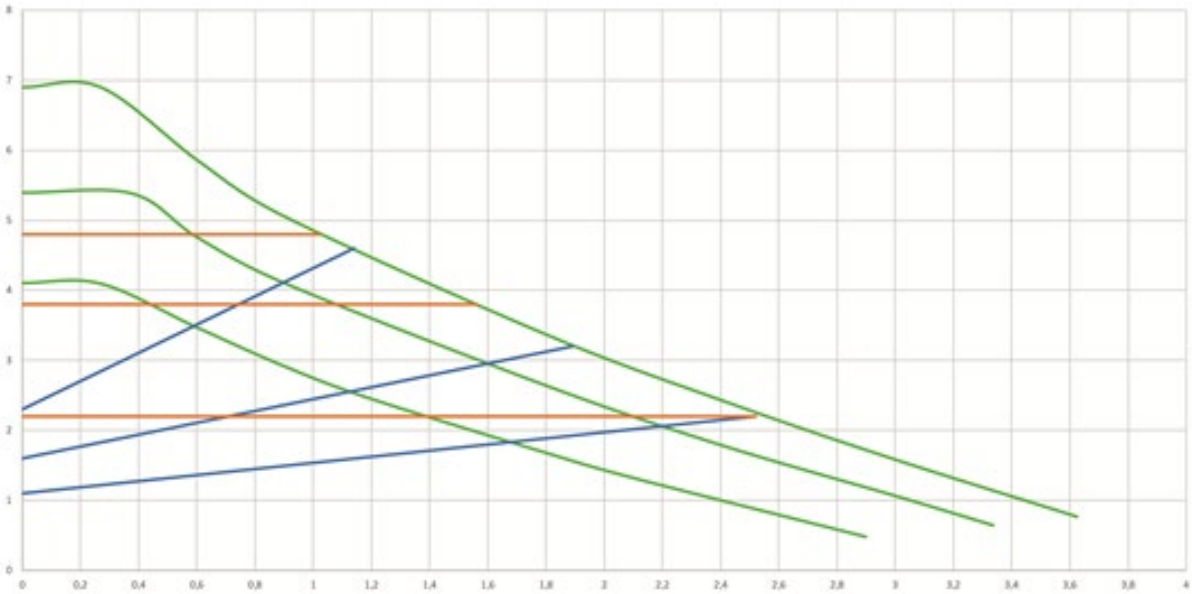

EVOSTA2 80/XXX

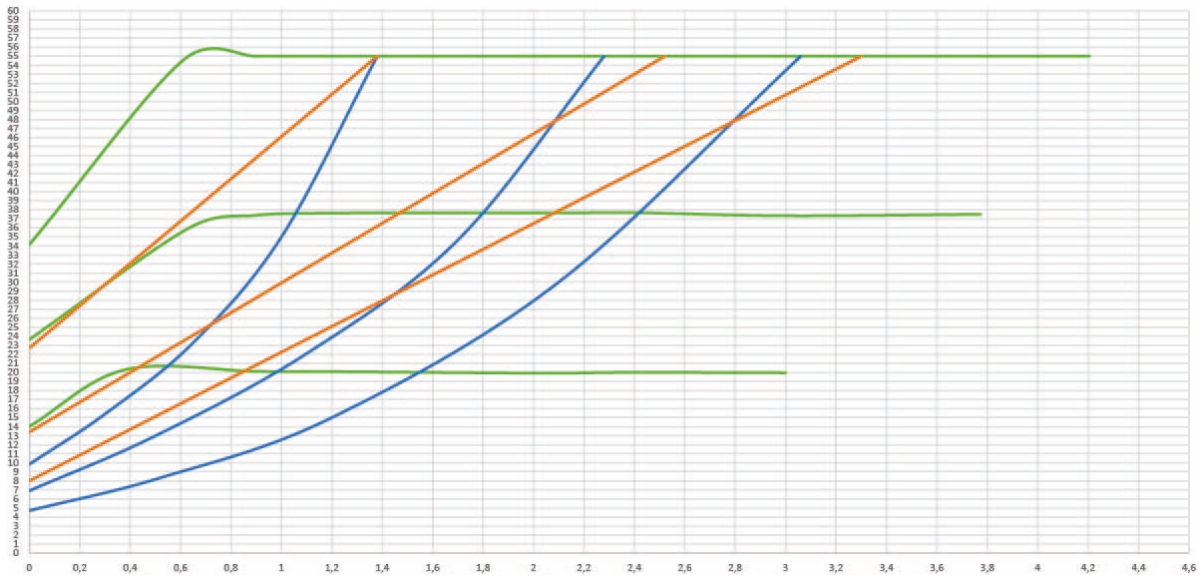
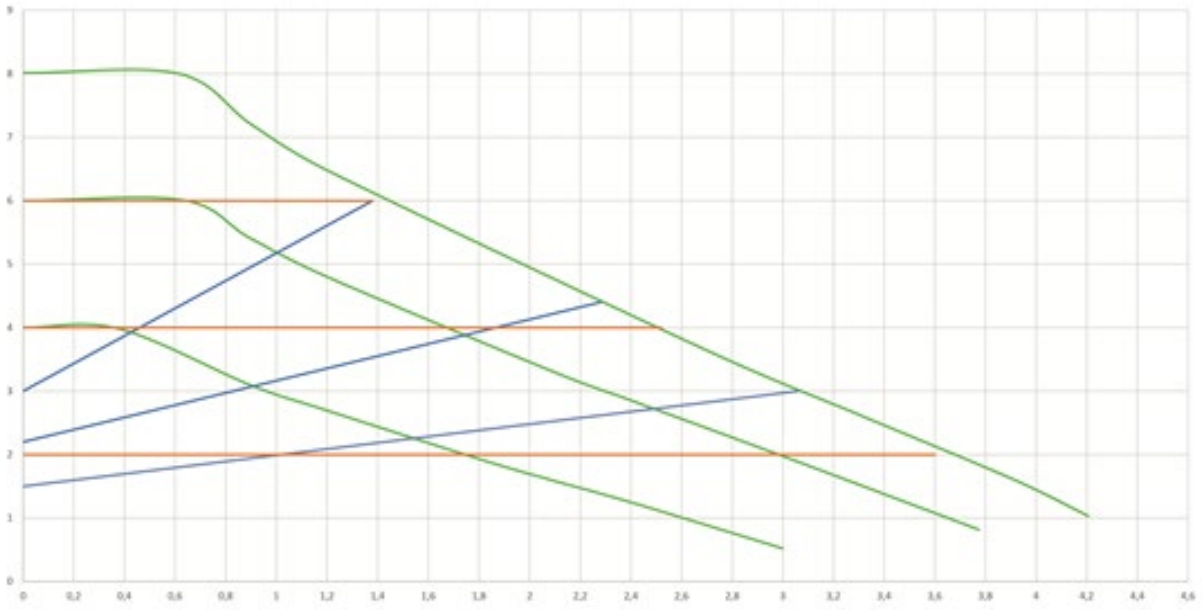

EVOSTA3 40/XXX

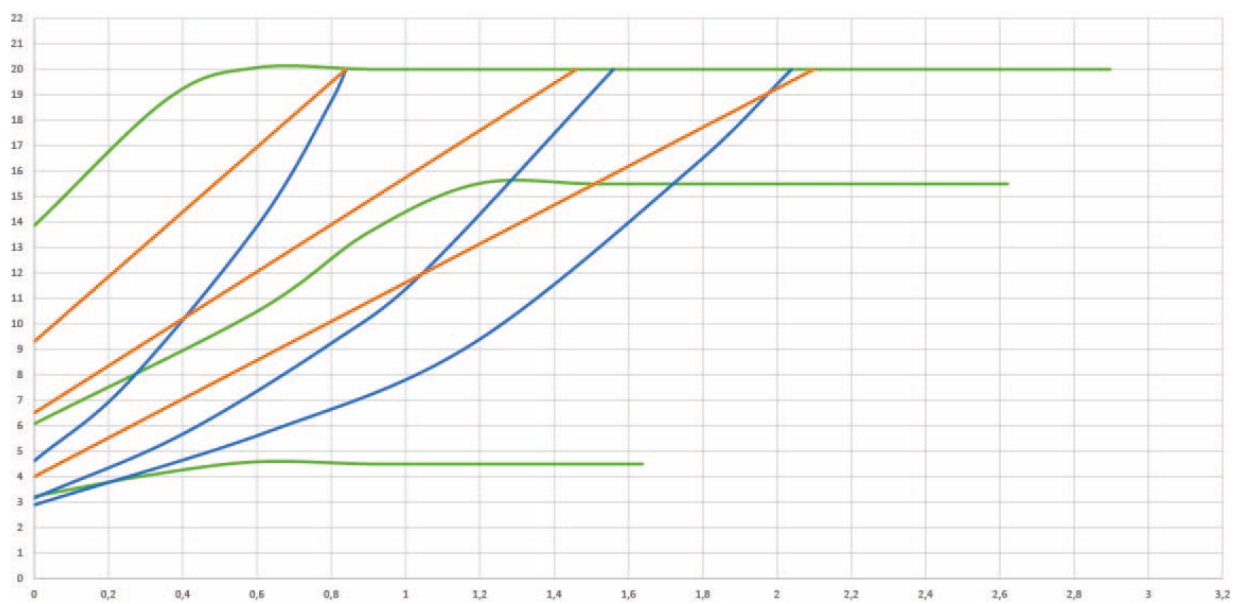
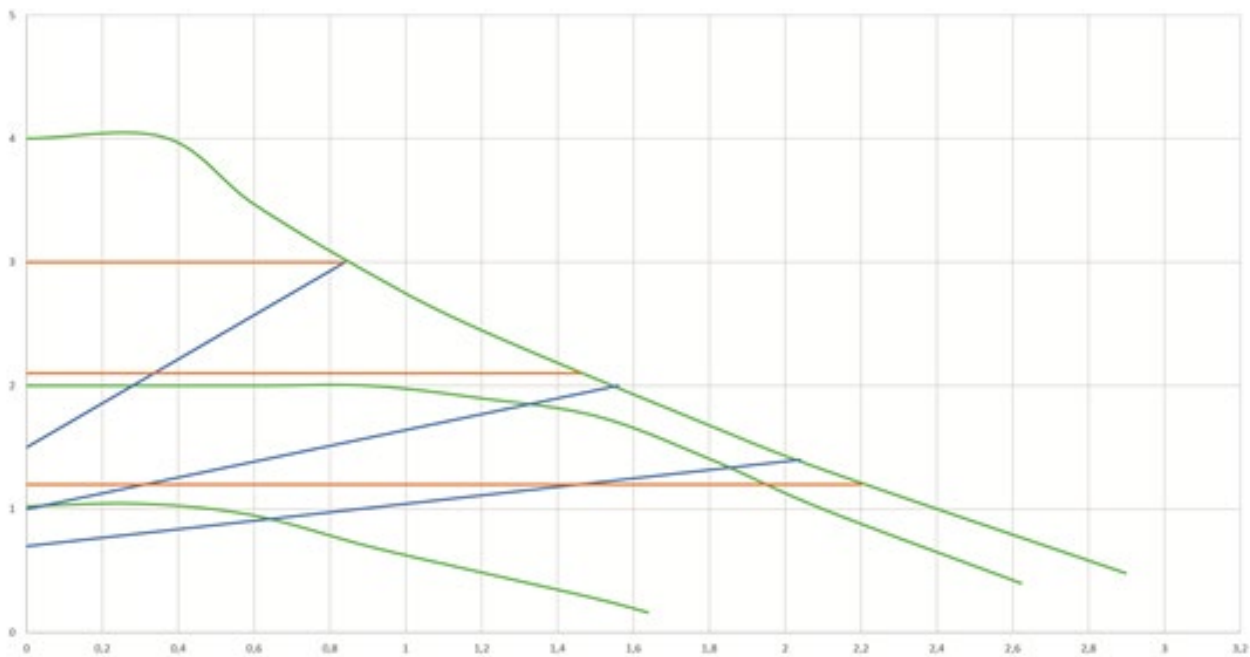

EVOSTA3 60/XXX

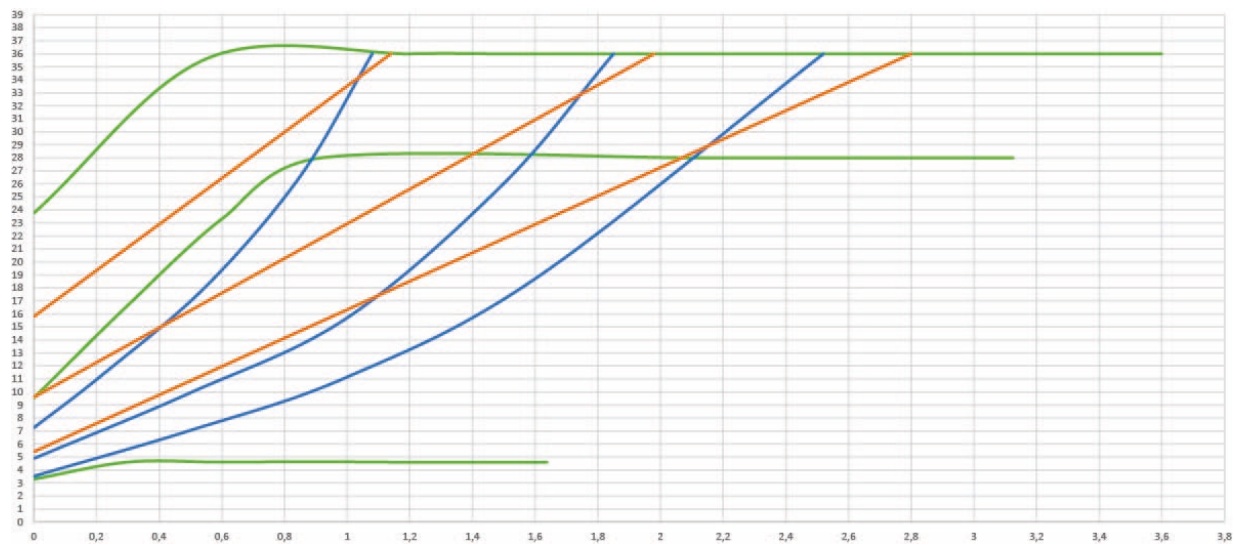
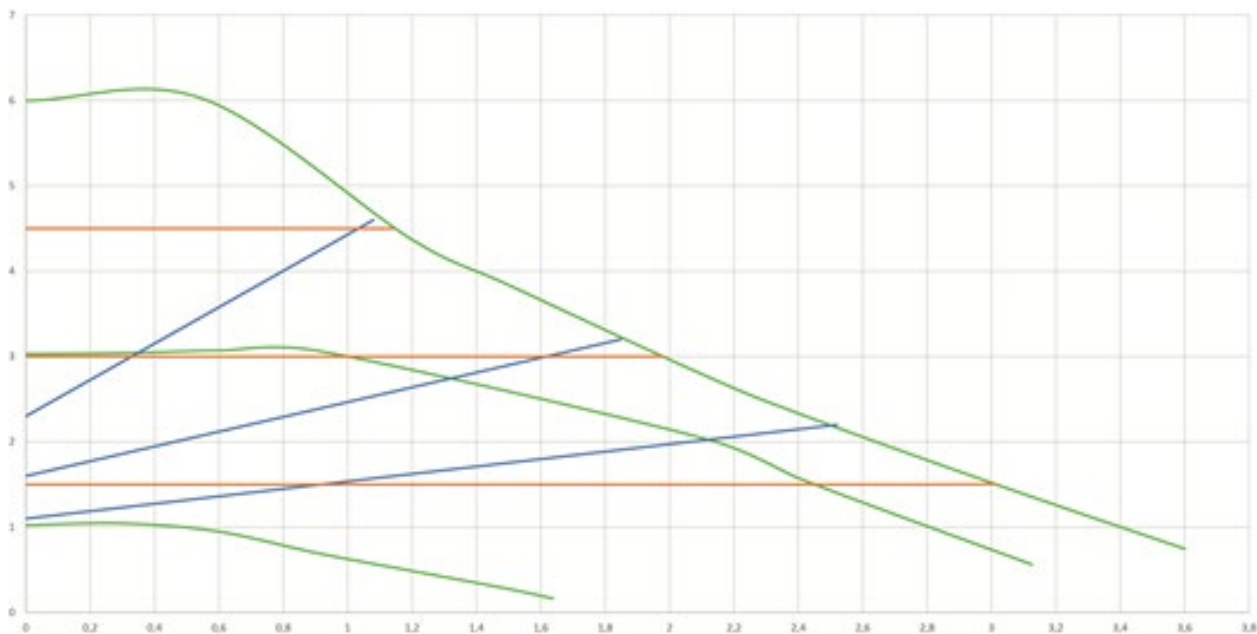

EVOSTA3 80/XXX

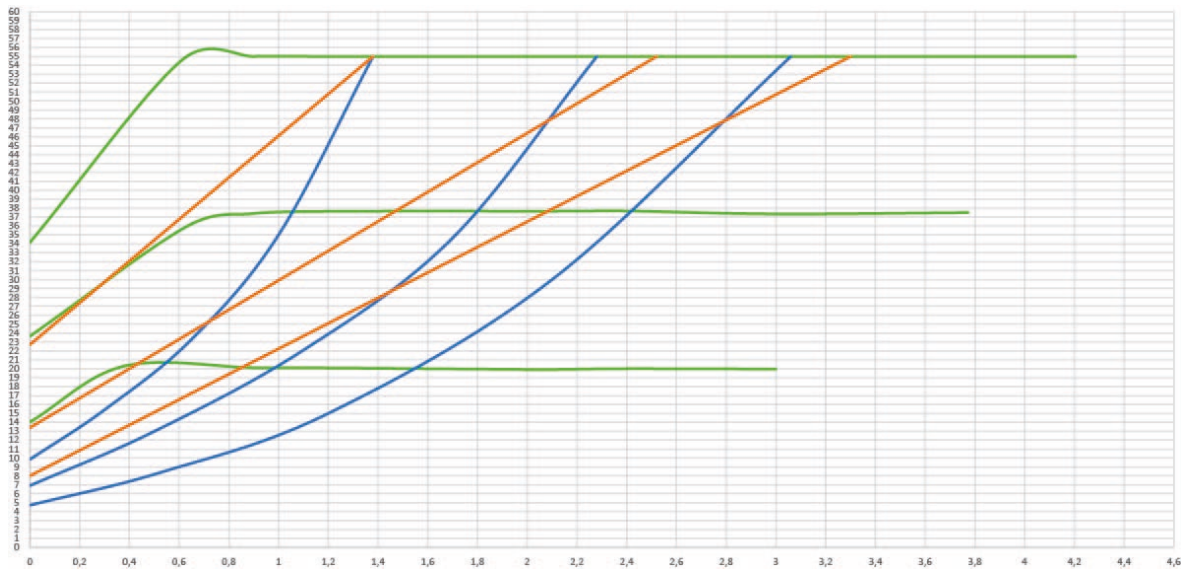
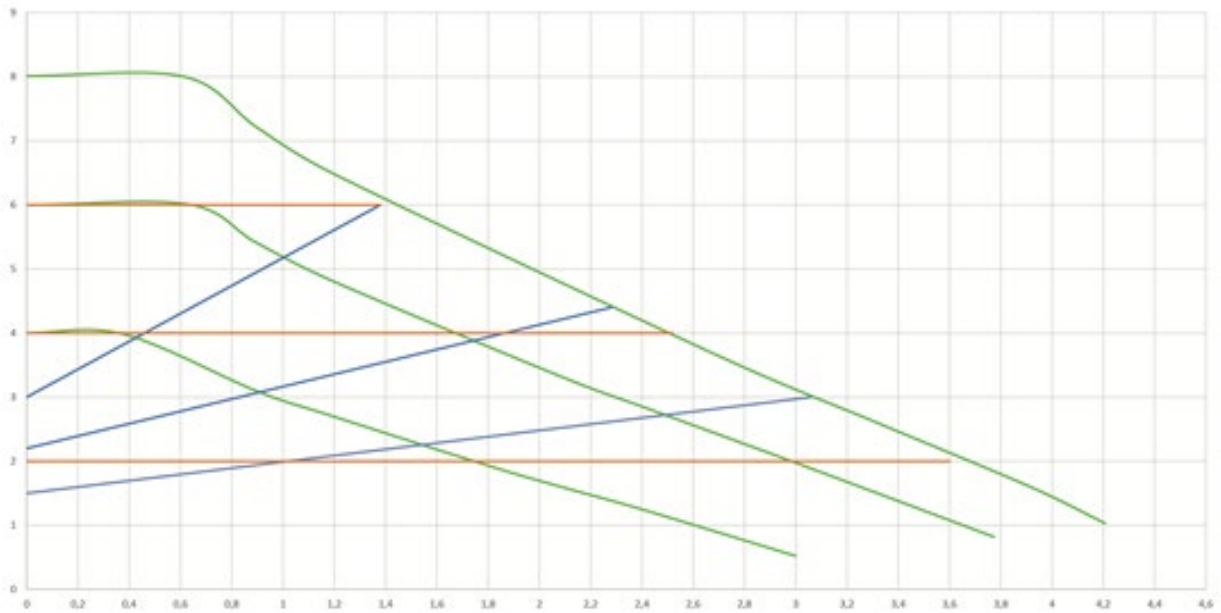

INDEX

1. LÉGENDE	57
2. GÉNÉRALITÉS	57
2.1 Sécurité	57
2.2 Responsabilités	57
2.3 Recommandations particulières	57
3. DESCRIPTION DU PRODUIT	58
4. LIQUIDES POMPÉS	58
5. APPLICATIONS	59
6. DONNÉES TECHNIQUES	59
7. GESTION	60
7.1 Stockage	60
7.2 Transport	60
7.3 Poids	60
8. INSTALLATION	60
8.1 Installation mécanique	61
8.2 Positions Interface Utilisateur	61
8.3 Rotation de l'interface utilisateur	63
8.4 Clapet antiretour	64
8.5 Isolation du corps de pompe (uniquement pour Evosta3)	64
9. CONNEXIONS ÉLECTRIQUES	65
9.1 Connexion ligne d'alimentation	65
10. DÉMARRAGE	67
10.1 Dégazage de la pompe	68
10.2 Dégazage automatique	69
11. FONCTIONS	69
11.1 Modes de régulation	69
11.1.1 Régulation à pression différentielle proportionnelle	69
11.1.2 Régulation à pression différentielle constante	70
11.1.3 Régulation à courbe constante	71
12. PANNEAU DE COMMANDE	71
12.1 Éléments sur l'Afficheur	71
12.2 Afficheur Graphique	72
13. RÉGLAGES D'Usines	74
14. TYPES D'ALARME	74
15. ENTRETIEN	74
16. MISE AU REBUT	74
17. DIMENSIONS	75
18. PERFORMANCES COURBES	77

INDEX DES FIGURES

Image 1: Liquides pompés, avertissements et conditions de fonctionnement	58
Image 2: Montage de EVOSTA2, EVOSTA3	61
Image 3: Position de montage	61
Image 4: Positions de l'interface utilisateur	62
Image 5: Positions de l'interface utilisateur	63
Image 6: Changement de position de l'interface utilisateur	63
Image 7: Isolation du corps de pompe	64
Image 8: Purge de la pompe	68
Image 9: Purge automatique de la pompe	69
Image 10: Afficheur	71
Image 11: Afficheur Evosta3	72



DAB PUMPS S.p.A.
Via M. Polo, 14 - 35035 Mestrino (PD) - Italy
Tel. +39 049 5125000 - Fax +39 049 5125950
www.dabpumps.com

10/18 cod.60187640
