

# Generation 6 Samsung Heat Pump Installation Manual



**REGISTER THIS PRODUCT  
ONLINE WITHIN 28 DAYS OF  
COMMISSIONING**

**IRELAND**



[www.joule.ie/register-a-product](http://www.joule.ie/register-a-product)

**NORTHERN IRELAND**



[www.jouleuk.co.uk/register-a-product](http://www.jouleuk.co.uk/register-a-product)

# Warranty Card

Please register your product online



**MUST BE COMPLETED AND  
THEN REGISTERED ONLINE  
TO COMPLETE WARRANTY**

Homeowner Name

Installer Name

Address

Address

Contact Tel.

Contact Tel.

Contact Email

Contact Email

Product	Product Installed	Serial Number		Installation Date
Cylinder	<input type="radio"/>		Located on cylinder badge	
Solar Thermal	<input type="radio"/>		Take from solar controller	
Solar PV	<input type="radio"/>		Ser. No. from String / Micro Inverter	
Air Source Heat Pump	<input type="radio"/>		Located on external heat pump badge	
Integrated Heat Pump and Cylinder	<input type="radio"/>		Located on cylinder badge	
Underfloor Heating	<input type="radio"/>		Project ref. on supplied schematic	
Was a Pre-Plumbed cylinder installed too?	<input type="radio"/>	<b>If installed, please fill out the Heat Pump Commissioning Sheet too</b>		

Joule Advance Installer

I accept the terms and conditions in the installation manual

# Heat Pump Commissioning Sheet

Please register your product online

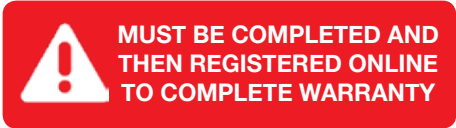

Site Contact

Address

Installer Contact

Installer Address

### Outdoor Unit Information

Model Number	<input type="text"/>	Serial Number	<input type="text"/>
Unit Location	<input type="text"/>		
Strainer	<input type="text"/>	Glycol added	<input type="text"/>
Fuse Rating	<input type="text"/>	Mains Cable Size	<input type="text"/>
Drainage For Outdoor Unit	<input type="text"/>	Unit Correctly Mounted	<input type="text"/>
Water System Flushed	<input type="text"/>	Water System Filled And Purged	<input type="text"/>
Flow Switch fitted	<input type="text"/>	Flow And Return Lines Insulated	<input type="text"/>
Glycol Concentration	<input type="text"/>	Space around unit	<input type="text"/>

\*Glycol level around 20% check with glycol manufacture for details

### Refrigerant Piping For Split System

Strength Pressure	<input type="text"/>	Tightness Test Pressure	<input type="text"/>	kg	Vacuum Level	<input type="text"/>
Refrigerant Piping Length	<input type="text"/>	Additional Charge Amount	<input type="text"/>	bar	Total System Charge	<input type="text"/>

### Outdoor Unit Operation Data

Power Supply	<input type="text"/>	Running Amps	<input type="text"/>	Delta T (ΔT)	<input type="text"/>
Ambient Temp	<input type="text"/>	Air On Temp	<input type="text"/>	Air Off Temp	<input type="text"/>
Flow Temp In	<input type="text"/>	Flow Temp Out	<input type="text"/>		

Please continue on next page

# Heat Pump Commissioning Sheet

Please register your product online



**MUST BE COMPLETED AND  
THEN REGISTERED ONLINE  
TO COMPLETE WARRANTY**

## Heating Controls

Ground Floor Heat Emitter	<input type="text"/>	Type of Control Used	<input type="text"/>	Serial Number	<input type="text"/>
1st Floor Heat Emitter	<input type="text"/>	Type of Control Used	<input type="text"/>	Blending Valve Fitted	<input type="text"/>

Type of control i.e. Underfloor heating system, programmable room stat, etc.

## Tank And Mim Unit Data

Tank Manufacture	<input type="text"/>	Model Number	<input type="text"/>	Serial Number	<input type="text"/>
DHW Storage	<input type="text"/>	Solar Installed	<input type="text"/>	Blending Valve Fitted	<input type="text"/>
Control Box Location	<input type="text"/>	Benchmark Book Completed	<input type="text"/>	Tank Sensor Fitted	<input type="text"/>
Fuse Rating For Mim Unit	<input type="text"/>	Cable Size	<input type="text"/>	Vented or Unvented	<input type="text"/>
Immersion Heater Volts	<input type="text"/>	Flow And Return Lines Insulated	<input type="text"/>		

## Space Heating Field Settings

Menu Code	Function	Default	Site Settings
2011	Low Ambient temp for weather comp	-10	
2012	High Ambient temp for weather comp	+15	
2021	Flow temperature at low ambient point (2011) Zone 1	+40	
2022	Flow temperature at high ambient point (2012) Zone 1	+25	
2031	Flow temperature at low ambient point (2011) Zone 2	+50	
2032	Flow temperature at high ambient point (2012) Zone 2	+35	
2091	External Run input for Zone 1 ( Room stat ) (Not Use, Recommended-Use (Signal only ON/OFF), Use(Signal ON/OFF) or WL Interlink OFF(Water Pump1) Use(Signal ON/OFF) or WL Interlink OFF(Water Pump2) Use(Signal ON/OFF) or WL Interlink OFF(Water Pump3)	0 (No)	
2092	External Run input for Zone 2 ( Room stat ) (Not Use, Recommended-Use (Signal only ON/OFF), Use(Signal ON/OFF) or WL Interlink OFF(Water Pump1) Use(Signal ON/OFF) or WL Interlink OFF(Water Pump2) Use(Signal ON/OFF) or WL Interlink OFF(Water Pump3)	0 (No)	
2093	Remote Controller Room Temp Control	1	

# Heat Pump Commissioning Sheet

Please register your product online

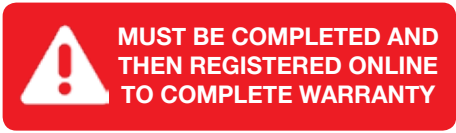

## Settings for Twin Heat Pump Installation & Hybrid Systems

Menu Code	Function	Default	Site Settings
4021	Enables control output for back up heat pump (0=No 1=Yes)	0	
4024	Ambient temperature below which the slave will assist	+10	
4031	Tells the Master unit that a backup boiler is fitted (0=No 1=Yes)	0	
4032	Tells the Master unit to use the boiler as back up at the value of 4033. ( Set to 1)	0	
4033	Ambient condition for the boiler to be enabled	-15	

## Domestic Hot Water & Heat Pump Settings

Menu Code	Function	Default	Site Settings
3011	Hot water cylinder fitted (0= No 1=Yes)	0	
3021	Heat Pump Max Temp for DHW	50	
3024	Min. space heating time	5	
3025	Max. cylinder heating time from heat pump before turning back to heating zones*	30	
3032	Max. cylinder heating time from heat pump before turning on immersion to support it**	20	
3041	Anti-Legionella function (0=Off 1=Yes)	1	
3042	Day of Anti-Legionella Function	Friday	
3043	Start Time of Anti Legionella function	23 Hrs	
3044	Target Temp	70	
3045	Hold Time at 3041	10	
3051	Hotwater Boost Function (0=Off 1=On)	0	
3052	Hotwater Boost Timer duration x10 Min	6 (1hr)	
3081	Back Up Heater ( 1st Step )	0	
3082	Back Up Heater ( 2nd Step )	0	
3083	Booster Heater Capacity	3	

\*\*30 = Domestic Hot Water Tank ( additional function )

\*3025 = 200 Ltr Cylinder = 50                      \*3025 = 300 Ltr Cylinder = 90

\*\*3032 = 200 Ltr Cylinder = 50                      \*\*3032 = 300 Ltr Cylinder = 90

Installer's Signature

Print Name

Date

# Heat Pump Installation Checklist

Please register your product online



**MUST BE COMPLETED AND  
THEN REGISTERED ONLINE  
TO COMPLETE WARRANTY**

## Heating Controls

Is the unit installed the correct distance from nearest boundaries?

Is the unit secured correctly to antivibration mounts via rubber mounts?

Is the unit mounted plumb level?

Is condensate drain kit fitted? (drain kit located inside HP access door)

If unit is mounted on wall brackets, is drip tray installed?

## Heat Pump Plumbing (Outdoor)

Is correct size pipe work used?

Are flexible antivibration hoses fitted and washers used?

Are heat pump isolation valves fitted out at the heatpump?

Is Y-Strainer fitted on the return pipework to heat pump and fitted in the correct orientation?

Is flow and return pipe work connected the right way around?

Is Primary flow and return pipework insulated?

## Cylinder Plumbing (Indoor)

Is the flow switch installed on the primary pipework and fitted in the correct orientation? (Smart Plumb Compact not applicable)

Is the flow switch installed on the primary horizontal pipework with 150mm pipe work each side free of a bend or appliance? (Smart Plumb Compact not applicable)

Is Flow and Return pipe work connected the right way around?

Is the heating expansion vessel correctly sized, secured and charged to correct pressure? (Smart Plumb Compact not applicable)

Is the Potable expansion vessel secured and charged to the correct pressure?

Are all pump valves and isolating valves fully open?

Has system been completely flushed of air and charged to the correct operating pressure of 2 bar?

Are all safety valves and tundish drained through a metal pipe to an appropriate drain point?

# Heat Pump Installation Checklist

Please register your product online



**MUST BE COMPLETED AND  
THEN REGISTERED ONLINE  
TO COMPLETE WARRANTY**

## Radiator/UFH Plumbing

Has all air been removed from emitters?

Have all emitters been balanced correctly?

If UFH is installed, have correct flowrates been set?

If UFH is installed, are all valves on manifolds/pumps fully open?

## Heat Pump Wiring

Is the correct size breaker used for heatpump?

Is an isolation switch installed for the heat pump and mounted on a fixed structure out beside heatpump?

Is the correct size power supply cable used for heat pump?

Are all cable protrusions avoiding condensate tray?

Is the correct communication cable installed and wired into correct terminals?

## Cylinder Wiring

Is the correct size breaker used for controller on cylinder?

Is an isolation switch installed for controller and mounted on a fixed structure beside Controller?

Is the correct size power supply cable used for controller on cylinder?

Is the correct communication cable installed and wired into correct terminals?

Is the flowswitch wired back into correct terminal on control panel? (Smart Plumb Compact not applicable)

## Heating Controls/Stats Wiring

Is each zone/floor corresponding with the correct zone valve?

Are all heating controls powered from controller on cylinder?

Are all heating controls wired and working?

# Heat Pump Installation Checklist

Please register your product online



**MUST BE COMPLETED AND  
THEN REGISTERED ONLINE  
TO COMPLETE WARRANTY**

Homeowner Name

Address

Contact Tel.

Contact Email

Installer Name

Address

Contact Tel.

Contact Email

Installer's Signature

Print Name

Date

Heat Pump must be commissioned within 30 days of installation in order to avail of warranty registration. If it is found that your system cannot be commissioned due to inadequate installation, the client will have 2 weeks to get issues rectified and recommissioned to avail of warranty registration. Charges may apply if a second call out is required by a Joule representative.



# Table Of Contents

10	Commissioning, Service & Maintenance Package
11	Heat Pump Warranty
16	Joule Cyclone Warranty
17	Pre Installation Notes
18	First Fix Notes
20	Locating The Outdoor Unit
22	Installing The Unit
24	Condensate Management
26	Initial Start Up
<b>28</b>	<b>Air Source Heat Pump &amp; Smartplumb - 1 Heating &amp; 1 DHW</b>
28	• Mechanical & Electrical Diagram
30	• Field Setting Parameters
<b>32</b>	<b>Air Source Heat Pump &amp; Smartplumb - 2 Heating &amp; 1 DHW</b>
32	• Mechanical & Electrical Diagram
34	• Field Setting Parameters
<b>36</b>	<b>Air Source Heat Pump &amp; High Gain Indirect (1 Heating &amp; 1 DHW)</b>
36	• Mechanical & Electrical Diagram
38	• Field Setting Parameters
<b>40</b>	<b>Air Source Heat Pump &amp; High Gain Indirect (2 Heating &amp; 1 DHW)</b>
40	• Mechanical & Electrical Diagram
42	• Field Setting Parameters
<b>44</b>	<b>Air Source Heat Pump &amp; High Gain Indirect (2 Heating &amp; 1 DHW)</b>
44	• Mechanical & Electrical Diagram
46	• Field Setting Parameters
<b>48</b>	<b>Air Source Heat Pump &amp; High Gain Indirect (2 Heating &amp; 1 DHW)</b>
48	• Mechanical & Electrical Diagram
50	• Field Setting Parameters
<b>52</b>	<b>Air Source Heat Pump &amp; Smart Plumb Compact (2 or 3 Heating &amp; 1 DHW)</b>
52	• Mechanical & Electrical Diagram
56	• Transport & Handling
58	• Suitable Location
59	• Pipe Connections & Electrical Entry Point
60	• Temperature & Pressure Relief Valve Pipework
63	• Piping Diagram
64	• Heating System Connection
66	• Potable Pipework
68	• Commissioning
69	• Maintenance
70	• Field Setting Parameters
72	Starting The Heat Pump
74	Controller Symbols
76	Button Functions
78	Fault Codes
81	Trouble Shooting
82	Control Kit EHS Monoblock Wiring
88	Service Record



# Commissioning, Service & Maintenance Package

## Commissioning

From as little as £480/€578 Inc VAT

## Annual Servicing

From as little as £360/€434 Inc VAT per year

All Samsung Air Source Heat Pumps supplied by Joule must be serviced annually to validate the product warranty under the terms of the EUW agreement. Items that must be inspected annually to validate the warranty include,

- Check outdoor fan motor and lubricate if needed
- Check electrical wiring, contacts and terminals; repair as required
- Check all safety components
- Check compressor operation
- Check indoor thermostat operation
- Check defrost and heating modes (winter only)
- Check for excessive noise and vibration
- Check refrigerant charge
- Inspect air filters
- Check all safety and pressure switches
- Check motor and heaters/voltage/amperes

You must ensure that if you do not choose a Joule service package then the service must be carried out annually by a suitable qualified engineer to validate the terms of the Joule EUW agreement.

## Heat pump Maintenance Package

Joule's heat pump maintenance package entitles you to an annual maintenance visit, during which our engineer will ensure that your Samsung heat pump supplied by Joule is operating within the optimum conditions to maximise energy efficiency. Any potential issue can be dealt with by a Joule engineer. You will also be entitled to a discount on the cost of spare parts and labour.

## Maintenance Package Response Times

Joule will schedule the planned annual maintenance visit with you, usually during the off peak (Summer, Autumn) season. In the unlikely event of a fault, we will endeavour to respond as quickly as possible

## How Much Does The Heat Pump Maintenance Package Cost?

The maintenance package costs £360/€434 inc VAT per year and is payable in ad-vance before we visit your premises. If any parts or remedial actions are required, we will provide an additional quotation for this work.

All service offers are subject to payment in advance by cleared cheque or by debit/credit card. The comprehensive service is available on a monthly direct debit plan. All service prices are inclusive of VAT.

# Warranty

## Registration Procedure

A Samsung accredited installer to..



## Warranty Procedure

# Warranty

## Performing Warranty Work

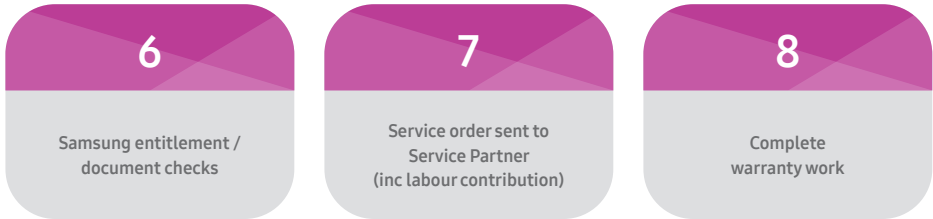

## Warranty Reimbursement (by distributor/service partner)



## Standard Warranty Period And Extended Warranty Period

1. The warranty period starts on the date of installation as shown on the commissioning report. The standard warranty period ends 24 months later. By registering the product(s) which can be done either by yourself, or by the reseller from whom you have purchased the products (the “Reseller”) within 28 days after the installation date, you will receive an additional 1/2/5 year extended limited warranty service depending on the product type which will bring the total period of coverage to 3/5/7 years from the date of installation. All of the terms set in this Statement of Limited Warranty shall apply to any extended warranty. The method of service and operating conditions will be as described in the original warranty statement provided with the Samsung Product.

## Warranty: Redemption Process & Details

1. This promotion cannot be used in conjunction with any other promotion(s) or special bid/tender pricing offered by Samsung Electronics.
2. To redeem and claim the Extended Warranty, all details MUST be sent to ([uk.corporate@samsung.com](mailto:uk.corporate@samsung.com)) within 28 days of the installation date to validate the additional warranty.
3. This offer applies to models purchased after 00:01hrs (GMT) on 1st May 2016.
4. Upon registration the claimant will be sent an email confirmation with notification of registration and a related reference number for the claim being registered on.
5. A copy of your invoice and commissioning report MUST be submitted as proof of purchase.
6. Proof of dispatch will not be accepted as proof of receipt.
7. The 7 Year Extended Warranty is not transferable and no alternative will be offered.

## Statement For Samsung

1. This offer only applies to the purchase of a new (not second-hand) Samsung air conditioning Product which is sold in the UK or ROI after 1st May 2016

Product	Model	Warranty Type
All DVM/EHS/ERV Product	various	7 years On Site
All CAC Product	various	5 years On Site
All RAC Product	various	3 years On Site

2. For customers outside the UK & ROI please refer to the country specific warranty information that came with your product.
3. All Extended Warranty Redemptions must be registered online within 28 days of installation.
4. This Promotion is only available to end user customers who are using the products for business purposes.
5. Employees or agents of Samsung or their families or households or anyone professionally connected to this promotion is not eligible.
6. By registering for the Extended Warranty you agree to be bound by these terms and conditions.

## Extent Of Warranty

During the extended warranty period Samsung continues to warrant that the Samsung Product shall be free from defects in materials and workmanship. If the relevant product does not function as warranted, against defective materials or workmanship, you should contact the Samsung Support Hotline.

Samsung Maintenance Parts, Supplies and Optional accessories (i.e. consumables), supplied as part of the initial Samsung Product installation and listed in the Samsung Product User Guides, is warranted against defective materials or workmanship for the first 6 months, from date of Samsung Product purchase or recommended average life volume, whichever is achieved first, but is excluded from the Extended Warranty period.

When Warranty service involves the exchange of a product or part, subject to applicable law, the item replaced becomes the property of Samsung.

The replacement item assumes the remaining warranty period of the original product.

Before you present the product(s) for On Site (IH) warranty service you must:

- ensure that the Product is available for Warranty repair, on Site at the registered address.

# Warranty

## Claim(s) For Warranty Service

To obtain a Warranty service, you must:

- Contact the Samsung Support hotline on 0843 596 2982 (UK) / 0818 717100 (ROI)
- Provide the full product model code and serial number
- Provide proof of activated extended warranty and proof of annual maintenance contract as per the e-mail confirmation sent at the time of online warranty registration(s)
- Provide a clear fault description and carry out any diagnostics as advised
- Comply with any reasonable instructions from Samsung or an Authorised Service Centre to allow you to receive the warranty service

## Transfer Of Product

If you transfer this product to another user, warranty service may be available to that user during the remainder of the standard 24 month warranty period, but not during any extended warranty period (i.e. the extended warranty is not transferrable).

## Exclusions

Samsung makes no representation or guarantee that the Samsung product(s) will operate uninterrupted or error free.

During the Extended Warranty Period, Samsung will only provide the Warranty in the UK and ROI. Samsung is not responsible for paying any travel or delivery costs where the product is located outside the UK or ROI.

Services performed by Samsung in rectifying damage or defect caused as a result of any excluded conditions shall be subject to additional charges for labour, transportation and parts.

The Extended Warranty is only available if you have an ongoing maintenance contract in place with a maintenance provider approved by Samsung, under which the product(s) must be checked at least once a year by that maintenance provider.

Warranty Service is not available to you if the product you present is:

- Defaced
- Altered
- Damaged beyond repair, or
- In need of a repair not included in Warranty service.  
(e.g Periodic Maintenance, consumable replacement and the repair or replacement of parts due to normal wear and tear) transportation damage, or any other damage caused by external factors (i.e. not damage caused by issues inherent in the manufacturing of the product)
- Does not match Product Model and serial number details as registered for Warranty service

To the maximum extent permitted by law, warranty service does not include repair of failures caused by:

- Modification or attachments
- Accidents or misuse
- Unsuitable physical or operating environment
- Third party products, generic or refilled e.g. maintenance units or replacement parts
- Maintenance by anyone other than Samsung or a Samsung Authorised Service provider
- Operation of a product beyond the limit of its duty cycle or Product specifications
- Products, components, parts, material, software, or interfaces not furnished by Samsung

**Neither Samsung nor its third party suppliers or resellers make any other warranty, guarantee, or condition of any kind, whether express, implied, legal or statutory, with respect to the product(s), and to the extent permitted by applicable law, specifically disclaim any implied, legal or statutory warranties or conditions or merchantability, fitness for a particular, general or normal purpose, satisfactory quality, durability and warranties against latent defects.**

## General Terms Of Promotion

1. These terms and conditions are governed by English law and come under the English courts shall have exclusive jurisdiction to settle and resolve any dispute which may arise in connection with the validity, effect, interpretation and/or performance of these terms.
2. By registering for the extended warranty you agree to be bound by these terms and conditions.
3. The Promoter shall have the right, where necessary, to undertake all such action as is reasonable to protect itself against fraudulent or invalid claim(s) including, without limitation, to require further verification as to the identity, and other relevant details of an entrant or claimant and/or the verification as to their qualifying purchase.
4. The Promoter shall not be liable for any interruption to this promotion whether due to force majeure or other factors beyond the Promoter's control.
5. The Promoter reserves the right, acting reasonably and in accordance with all relevant legislation and codes of practice, to vary the terms and conditions of this Promotion.
6. Promoter: Samsung Electronics (UK) Ltd, Samsung House, 1000 Hillswood Drive, Chertsey, Surrey, KT16 0PS. (Please do not send any Warranty applications to this address - they will not be registered for Warranty promotion)

# Warranty

## Joule Cyclone

The **JOULE Cyclone** stainless steel vessel carries a fully transferable 25-year guarantee against faulty materials or manufacture provided that:

- It has been installed in the United Kingdom or the Republic of Ireland as per the instructions provided in the installation manual provided with the cylinder and in accordance with all of the relevant standards, regulations and codes of practice in force at the time.
- It has not been modified in any way, other than by JOULE
- It has not been misused, tampered with or subjected to neglect.
- The system is fed from the public mains water supply.
- It has only been used for the storage of potable water.
- It has not been subjected to frost damage.
- The unit has been serviced annually.
- The Service Log Book has been completed after each annual service.
- The warranty card is filled in and a copy is sent by email to [warranty@joule.ie](mailto:warranty@joule.ie)

## Exclusions

The guarantee does not cover cylinders affected by the following;

- The effects of scale build up on the cylinder.
- Any labour charges associated with replacing the unit or its parts.
- Any consequential losses caused by the failure or malfunction of the unit.

Please note that invoices for servicing may be requested to prove that the unit has been serviced annually.

## Unvented Kit & Other Components

The expansion vessel and cold water controls supplied with JOULE models carry a 1-year guarantee. All other components that are fitted to, or supplied, with the unit carry a 1-year guarantee.



# Pre-Installation Notes

- Store the manual in a safe place in order to be able to use it as reference after installation. For maximum safety installers should always carefully read the following warnings.
- Store the provided manual in a safe location with the end user after installation, and remember to hand it over to the new end user if the Heat Pump & Cylinder unit is sold or transferred.
- The Air to Water Heat Pump is compliant with the requirements of the Low Voltage Directive (2006/95/ EC), the EMC Directive (2004/108/EC) and the pressure equipment directive (97/23/EC).
- The manufacturers shall not be responsible for damage originating from unauthorised changes or the improper connection of electric and hydraulic lines.
- Do not use units if you see some damages on the units and recognise something untoward such as loud noise, smell or burning.
- In order to prevent electric shocks, fires or injuries, always stop the unit, disable the protection switch and contact Joule's technical support if the unit produces smoke, if the power cable is hot or damaged, or if the unit is very noisy.
- Always remember to inspect the unit, electric connections, refrigerant tubes and protections regularly. These operations shall be performed by qualified personnel only.
- The unit contains moving parts and electrical parts which should always be kept out of the reach of children.
- Do not attempt to repair, move, alter or reinstall the unit by unauthorised personnel. These operations may cause product damage, electric shock and fires.
- Do not place containers with liquids or other objects on the unit.
- All the materials used for the manufacture and packaging of the air to water heat pump are recyclable. The packaging material and exhaust batteries of the remote controller (optional) must be disposed of in accordance with local regulations.
- The Air to Water Heat Pump containing a refrigerant must be disposed in an authorised centre or returned to retailer as special wastes.
- Wear protective gloves to unpack, move, install, and service the unit to avoid your hands being injured by the edge of the parts. Do not touch the internal parts (water pipes, refrigerant pipes, heat exchangers, etc) while running the units. If you need to adjust and touch the units, allow sufficient time for the unit to cool and be sure to wear protective gloves.
- In case of refrigerant leakage, try to avoid contact with the refrigerant because this could result in severe wounds.
- When you install the Air-to-Water Heat Pump in a small room, you must install adequate ventilation. In the event of a refrigerant leakage, ventilation will prevent the possibility of suffocation.

# First Fix Notes

## Primary Pipework From Outdoor Unit To Indoor Cylinder

- 5W – 28mm copper
- 9kW – 28mm copper
- 12kW – 28mm copper
- 16kW – 28mm copper
- Outdoor pipework should be fully insulated and protected from water and moisture.
- If outdoor pipework is required use Joule outdoor low energy loss pipework (supplied by the meter)

## Electrical Supply And Cable Requirements

- Shielded 0.75mm 2 core cable from outdoor unit to cylinder / wiring centre location.
- Shielded 0.75mm 2 core cable from wiring centre to samsung controller.
- Power supply to outdoor unit to be terminated with IP67 isolator located next to the unit.
- Power supply to indoor unit (MIM board) to be terminated switch fused isolator.

Outdoor Unit	Cable Size	Breaker Size
HHSM-G600005-1	4.0mm	16Amp
HHSM-G600008-1	4.0mm	20Amp
HHSM-G600012-1	6.0mm	25Amp
HHSM-G600016-1	6.0mm	32 Amp

Outdoor Unit	Cable Size	Breaker Size
MIM E03CN (5kW)	4.0mm	20Amp

- Power supply to the MIM units must connect to the RCD fitted inside of the MIM unit.

- When installing the outdoor unit take great care to install as per the detailed notes for installation locations. The Air-to-Water Heat Pump must have minimum clearance of 300mm at the rear of the unit and 1500mm at the front of the unit.
- The Air-to-Water Heat Pump must not be installed in a location without these clearances available.
- Condensation will form on the Air-to-Water Heat Pump. Ensure adequate provisions are put in place to prevent water forming on the ground beneath the Air-to-Water Heat Pump, resulting in a potential Health and Safety hazard.
- The Air-to-Water Heat Pump must be installed vertically and should not be tilted at an angle.

Cable Size	No. of Cores	Location
0.75mm	2 Core Screened	From indoor unit to outdoor unit. F1 & F2 Comms.
0.75mm	2 Core + Earth	From Zone 1 stat or Underfloor heating control centre to Indoor unit.
0.75mm	2 Core + Earth	From Zone 2 stat or Underfloor heating control centre to indoor unit.
0.75mm	2 Core Screened	From MIM unit to remote controller.

- A 5m head circulation pump must be installed on the flow pipework and a second 5m head circulation pump must be installed on the return pipework back to the Air-to-Water Heat Pump to ensure that minimum flow rates will be achieved (as per installation schematics). Installing a single circulation pump will not guarantee the correct flow rate. Unless using a Smart plumb cylinder or Low loss header/Buffer vessel.
- Site visits to solve a flow rate issue due to the installation of a single pump on the pipework are not covered under EUW and as such will incur a callout charge.
- Underfloor heating pipe centres to be equal to or less than 150mm.
- Standard radiators to be a minimum twice and up to 4 times the standard radiator size.
- No mixing sets to be used on the underfloor heating manifolds.
- All manifolds must have an individual pump to help circulate and maintain flow rate.
- All radiator zones must have individual pump to help circulate and maintain flow rate.
- All zones to be controlled using 2 port valves (22mm on heating zones and 28mm on hot water zone).
- 3 port valves are not to be used.
- Mechanical by-pass valve to be installed after pump on flow but before any zone valves.
- All underfloor heating circuits to be controlled from the run signal from the third party underfloor wiring centre.
- All radiator zones to be controlled from 3rd party time clock and stat.
- Hot water cylinder is controlled by the Samsung service controller.
- End user interacts with 3rd party controls only. It is the installers responsibility to ensure that attached designs are followed to achieve this or if a uniquely designed system is being installed the designer must allow for the 3rd party controls facility.
- Underfloor heating circuits are controlled by room stats.
- Use of time clocks to turn off underfloor heating circuits is not recommended.
- Room stats in underfloor heating circuits should not be turned off but set back to a lower temperature using appropriate heating setback control for periods of unoccupied use.
- The flow switch must be installed in horizontal pipework. Allow a minimum of 150mm horizontal pipework on each side of the flow switch.
- Air is the most prevalent cause of restricted flow in the system. Make sure that all pipework can easily be purged of air and that all air is removed from the system prior to starting the unit. Site visits to solve a flow rate issue due to the presence of air are not covered under EUW and as such will incur a callout charge.

# Locating The Outdoor Unit

## When Installing 1 Outdoor Unit

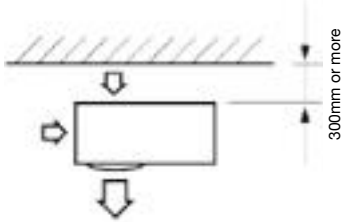

When the air outlet is opposite the wall.

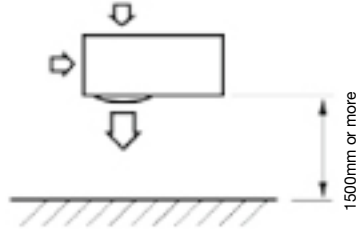

When the air outlet is towards the wall.

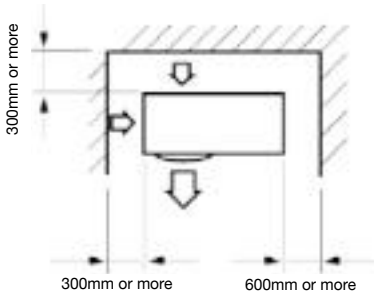

When 3 sides of the outdoor unit are blocked by the wall.

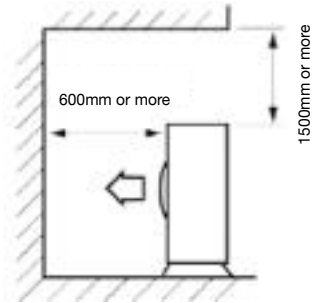

The upper part of the outdoor unit and the air outlet is towards the wall.

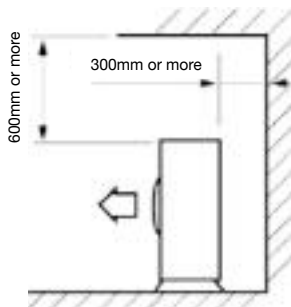

The upper part of the outdoor unit and the air outlet is opposite the wall.

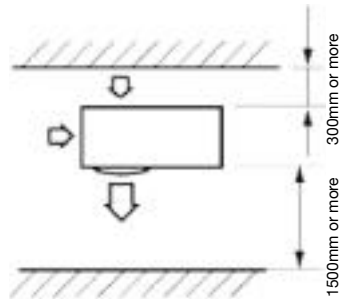

When front and rear side of the outdoor unit is towards the wall.

## When Installing More Than 1 Outdoor Unit

When the air outlet is toward the wall.

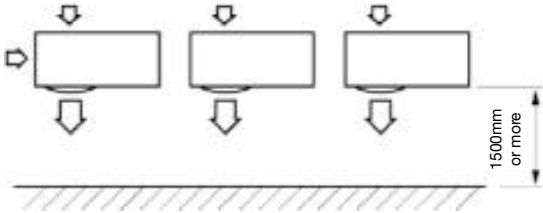

When 3 sides of the outdoor unit are blocked by the wall.

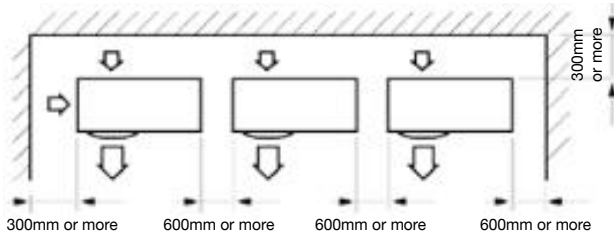

When front and rear side of the outdoor unit is towards the wall.

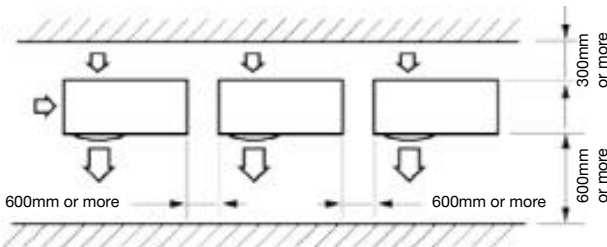

The upper part of the outdoor unit and the air outlet is opposite the wall.

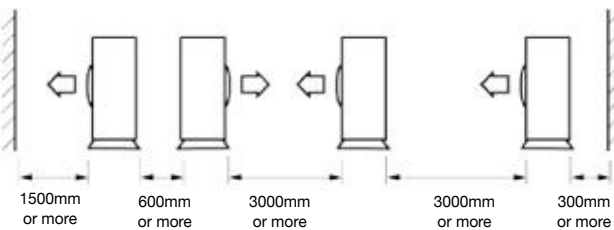

When front and rear side of the outdoor unit is towards the wall.

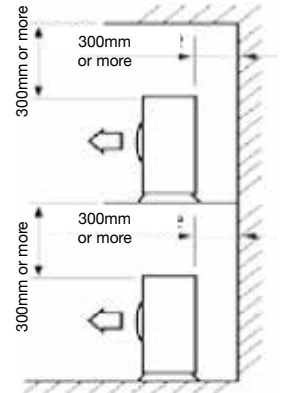

The units must be installed according to distances declared, in order to permit accessibility from each side, either to guarantee correct operation of maintenance or repairing products. The unit's parts must be reachable and removable completely under safety condition.

# Installing The Unit

## Outdoor Unit Installation

The outdoor unit must be installed on a rigid and stable base to avoid any increase in the noise level and vibration. Particularly if the outdoor unit is to be installed in a location exposed to strong or at a height, the unit must be fixed to an appropriate support (wall or ground).

## Fix The Outdoor Unit With Anchor

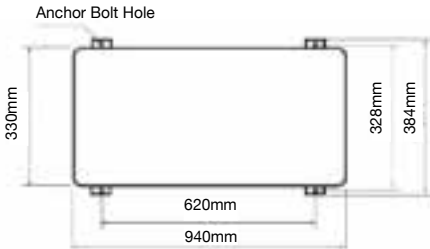

 The anchor bolt must be 20mm or higher from the base



- The anchor bolt must be 20mm or higher from the base surface.
- When tightening the anchor bolt, tighten the rubber washer to prevent outdoor unit bolt connection part from corroding.
- Make a drain outlet around the base for outdoor unit drainage.
- If the outdoor unit is installed on the roof, you have to check the ceiling strength and waterproof the unit.

## Outdoor Unit Support

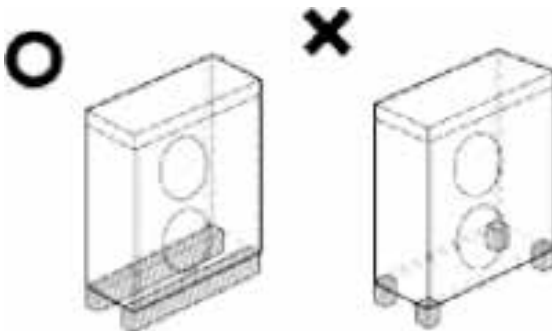

- Ensure the wall will be able to suspend the weight of rack and outdoor unit.
- Install the rack close to the column as much as possible.
- Install proper grommet in order to reduce noise and residual vibration transferred by outdoor unit towards wall.



When installing Air Guide Duct

- Check and make sure that screws do not damage the copper pipe.
- Secure air guide duct on guard fan,

## Selecting A Location In Cold Climates

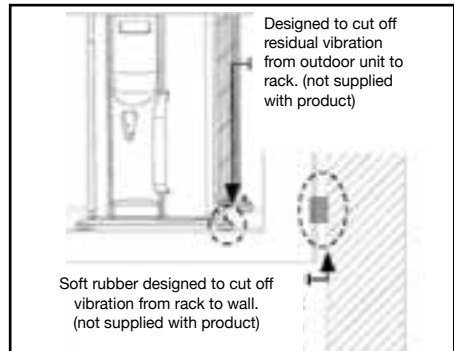
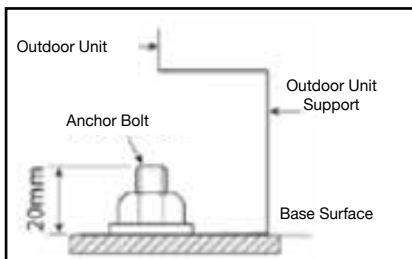

When operating the unit in a low outdoor ambient temperature, be sure to follow the instructions described below.

- To prevent exposure to wind, install the unit with its suction side facing the wall.
- Never install the unit at a site where the suction side may be exposed directly to wind.
- To prevent exposure to wind, install a baffle plate on the air discharge side of the unit.
- In heavy snowfall areas it is very important to select an installation site where the snow will not affect the unit. If lateral snowfall is possible, make sure that the heat exchanger coil is not affected by the snow (If necessary construct a lateral canopy).

1. Construct a large canopy.

2. Construct a pedestal. Install the unit high enough off the ground to prevent it being buried under snow.



# Condensate Management

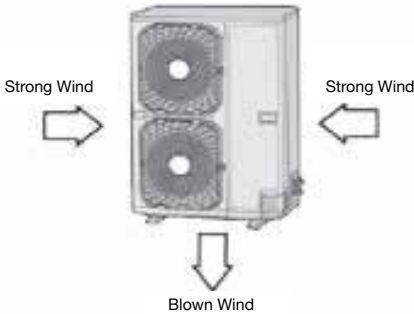

 Considering the direction of strong wind, the outdoor unit shall be installed. Strong wind can make the unit turned over so need to set side of the unit face the direction of wind, not front.

When the Air to Water Heat Pump is running in heating mode, ice can begin accumulate on the surface of the condenser.

To prevent ice from growing, the Heat Pump will go into defrost mode to melt the ice.

The water formed from the melted ice will fall to the base of the heat pump where it can escape to ground through the drain holes in the base. This will require a drain pit or soak hole beneath the Heat Pump to prevent water or ice from forming on the ground around the Heat Pump which may be a safety hazard.

If installing the Heat Pump on a wall, the supplied drain plug and drain hose can be fitted to pipe the water away to drain.

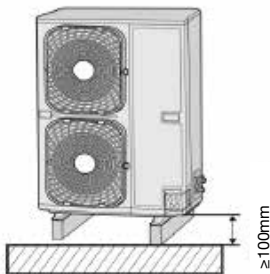

 If drain work is not enough, it can lead to system performance degradation and system damages

If the unit is not been installed over a gravel trap to allow for drainage then carry out the following steps:

1. Mount the unit on feet keeping the unit more than 100mm above the ground.
2. Connect the drain plug as shown above and a suitable hose to the plug.
3. Run the hose into a suitable drain located near by. If there is no drain nearby run the hose to an area where natural drainage can take place.
4. Never mount the unit on a wall frame without installing sufficient drainage management.



Drain Hole Ø 20 x 4ea

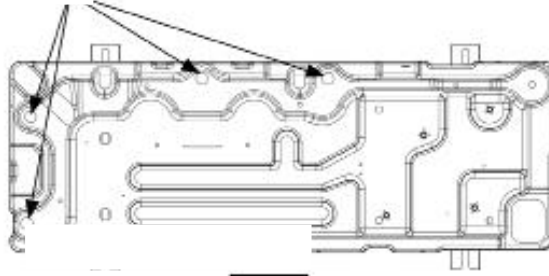

Drain Plug x 1ea



Drain Cap x 3ea



30mm

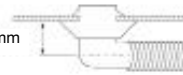

1. Prepare a water drainage channel around the foundation, to drain waste water from around the unit.
2. If the water drainage of the unit is not easy, please build up the unit on a foundation of concrete blocks, etc. (the height of the foundation should be a maximum of 150mm).
3. If you install the unit on a frame, please install a water-proof plate within 150mm of the underside of the unit in order to prevent the invasion of water from the lower direction.
4. When installing the unit in a place frequently exposed to snow, pay special attention to elevate the foundation as high as possible.
5. If you uninstall the unit on a building frame, please install a waterproof plate (field supply) within 150mm of the underside of the unit in order to avoid the drain water dripping.

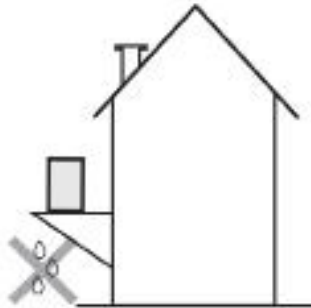

# Flow Sensor

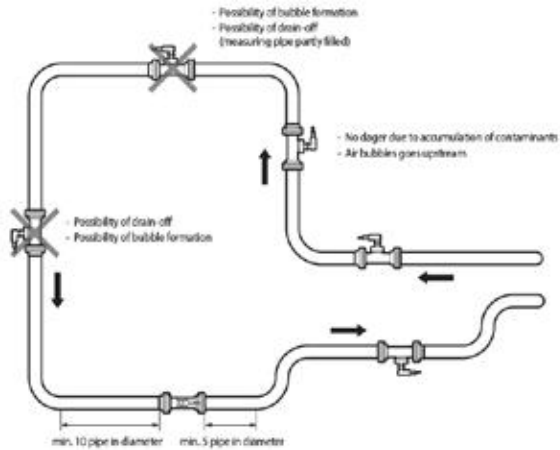

Supplied with the Pre Plumbed cylinder is a Flow Sensor and a Flow Meter.

The Flow Sensor should be mounted within 2 M of the Control Kit.

This lead can be extended, it is a 4 core cable, if you do extend ensure that the cores are not crossed.

The switch must be located indoors as it is only splash proof.

Ideally the Flow Switch will be mounted horizontally in the return line to the Outdoor unit.

The Switch must have a minimum of 300 mm of straight pipe either side of it.

The flow Switch plugs directly onto the MIM unit on Connections CSN 057

# Initial Start Up

Please refer to controller symbols and button functions on pages 60 & 61 for further guidance on the heat pump controls.

1. Ensure that both the outdoor and indoor units are correctly wired and plumbed prior to turning on.
2. Flush the system at 110% of system flow rate in both directions using suitable chemical.
3. Once the system has been power flushed you must now fill the system with Glycol.
4. The Glycol should be pre mixed before putting it into the system and a solar filling station is ideal for filling the system, use the connections on the fill/flush and flow meter to add the glycol.
5. Do not put Neat Glycol into the system, failure to do this may cause the glycol to block the heat exchanger or block the pipes within the heat emitter circuit.
6. Run the solar filling station for at least an hour to purge all the air from the system.
7. Turn on power to the indoor unit first. Then turn on power to the outdoor unit second.
8. The outdoor unit will start flashing numbers **00**, **01**, **02**, etc. It will then flash a message like **00 00**, **dE**, **F0** etc.
9. Once initiating disappears from the screen the system is ready for testing.

# Service Timer

**Enter** service menu

Highlight service timer

Use **right** hand arrow to enter

Service call number should be highlighted, use **right hand arrow** to enter

Using the arrows enter phone number, once done push **OK**

You will now return to service timer

Use **down arrow** to highlight installation date, then right arrow to enter.

Set date by using the arrows. Once complete push **OK** and you will return to service timer menu

Use ↶ to exit this screen

## How to setup service call number

1.

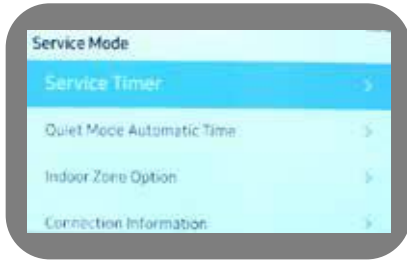

2.



3.



# How to view Energy Monitoring

In order to enable the energy monitoring function, please set FSV 3083.

Enter the service mode and go to FSV 3083 within the DHW settings.

Set 3083 to 3 kw.

Now use the  to return to the front screen.

Use the  to enter user menu, and use the arrows to highlight “Energy”

Push the ok button to enter this menu

Energy usage should be highlighted, push right arrow to enter

From here you have four options.

**Instantaneous usage**

**Weekly energy usage**

**Monthly energy usage**

Yearly energy usage

Use the arrows to navigate the menus.

Example: weekly usage> weekly consumption> display will then show current week, use left hand arrow to look at previous week.

Push the back key to return to previous sub menu or push several times to exit to home screen

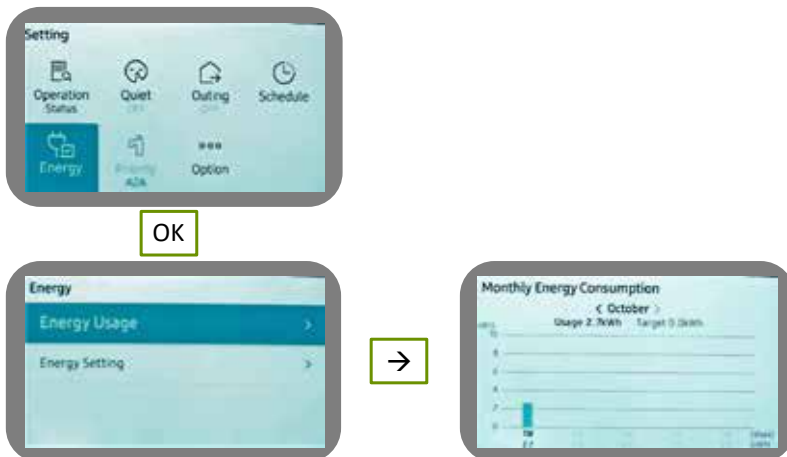

# AS Heat Pump & Smart Plumb Pre-plumbed 1 Heating & 1 Domestic Hot Water

## Mechanical Diagram

Legend			
1	Joule Smart Plumb DHW/Buffer Cylinder	10	DHW Heat Pump Stat Pocket
2	Samsung Heat Pump	11	Solar Probe Stat Pocket (Where Applicable)
3	Heating Expansion Vessel	12	DHW Immersion
4	28mm Y-Strainer	13	Buffer Tank Immersion (Where Applicable)
5a	Primary Pump Flow from Heat Pump	14	Buffer Tank Stat (Where Applicable)
5b	Primary Pump Return to Heat Pump (Where Required)	15	DHW High Limit Stat
6	Flow Regulator/Flush and Fill Unit	16	Heating Zone Circulating Pump
7	28mm Buffer 2 Port Zone Valve	17	UFH Circulation Pump
8	28mm DHW 2 Port Zone Valve	18	Samsung Heat Pump Flow Switch
9a	22mm 2 Port Zone Valve Heating Zone 1	19	2 Pole 20A NO Relay
9b	22mm 2 Port Zone Valve Heating Zone 2	25	ELCB
		26	Automatic Bypass Valve

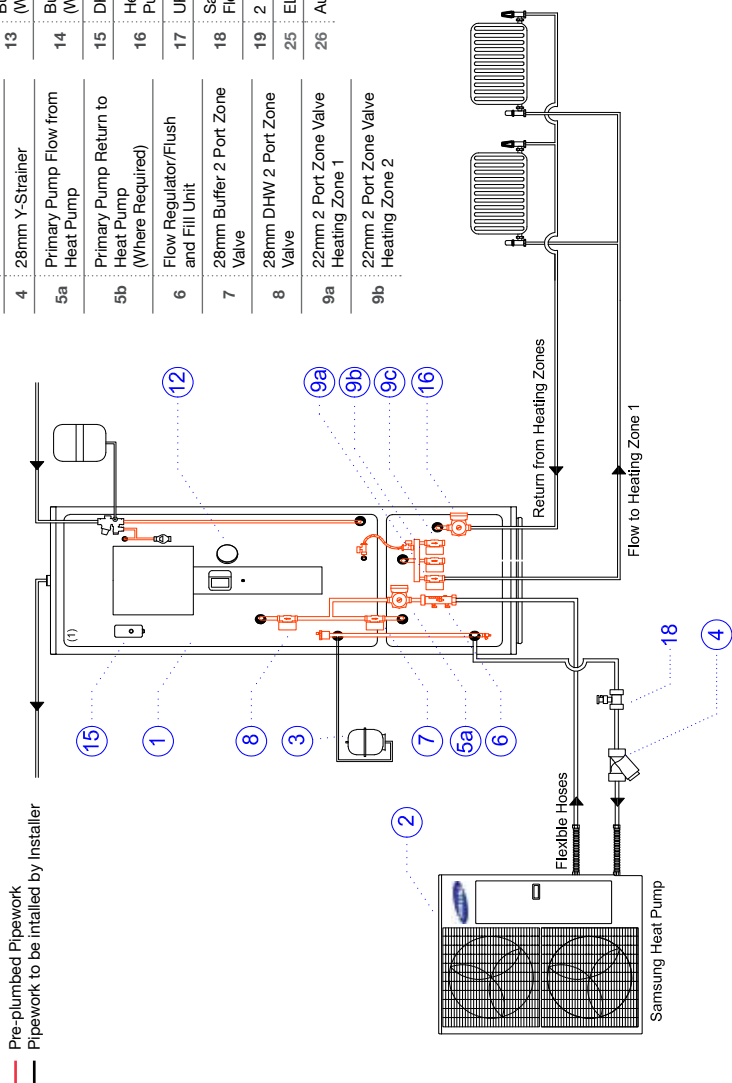

# Electrical Diagram

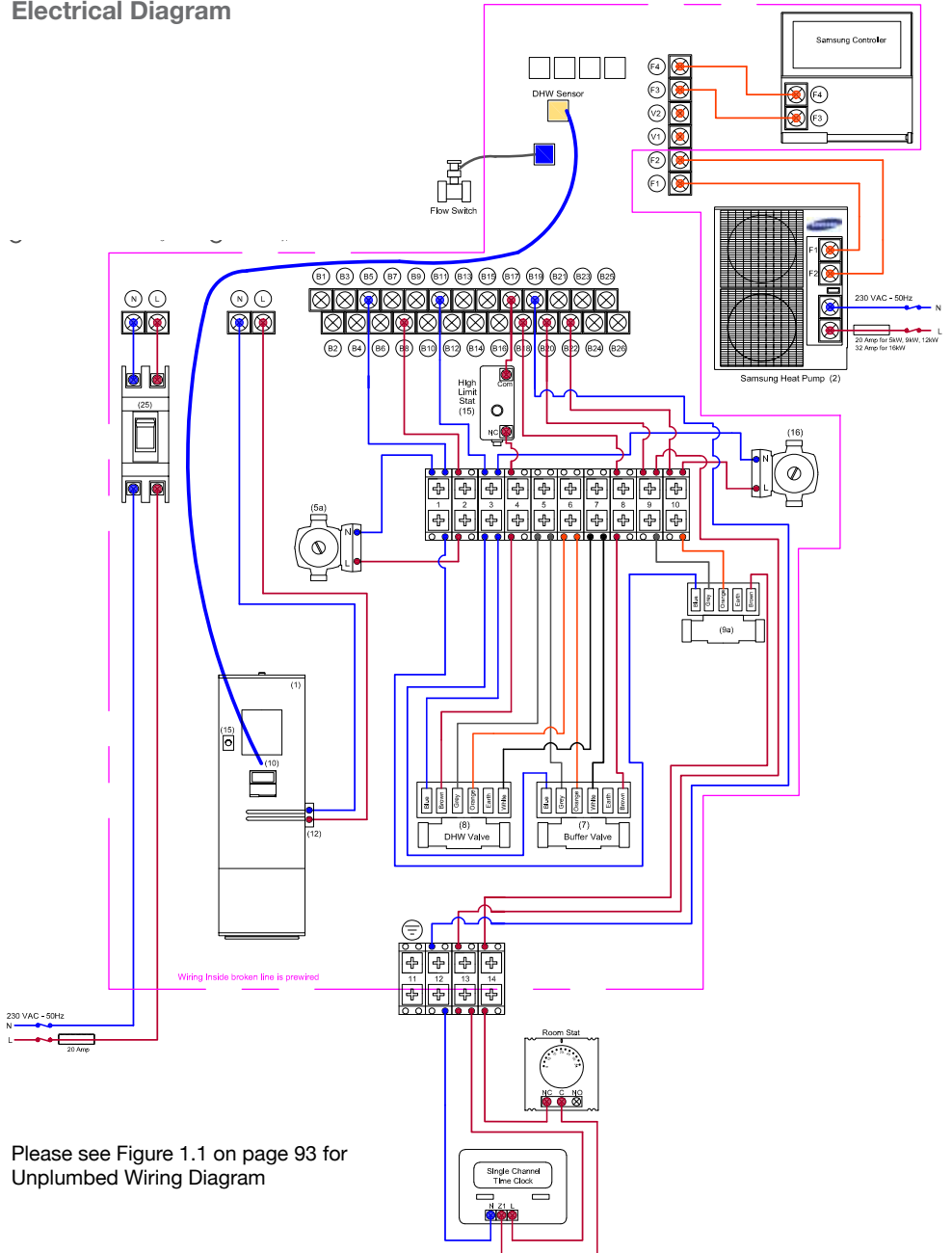

Please see Figure 1.1 on page 93 for Unplumbed Wiring Diagram

# Field Setting Parameters

## How to enter Service Mode

Using two hands, **push and hold** the up and down arrows for **10 seconds**



Password will appear, the password is **0202**

Use arrows to enter password

## Accessing And Adjusting The Field Settings

Use  to highlight field setting value



Push  arrow to enter

Use   arrows to select sub menu required.

Example for weather comp and heating flow high light 20 – water law

Push  arrow to enter sub menu

You will see the individual settings within this menu.

Use  and  to set FSV

Example 2011 Low set is 15, High set is 2.0

Once set push **OK** and Saving FSV will be displayed.

You will then **return** to the heat sub menu.

You can then use  and  arrows to highlight other heat settings push right arrow to enter.

To go back to FSV menu use the back key and you can then move to other sub menus such as DHW.

To **exit FSV mode** push  until you return to the front Screen.



## Field Setting Parameters For Smart Plumb Cylinder Units - 2 Zone



If you set a field setting and go back to check it, it will not have changed. The field setting does not get written to the PCB unless you push SET after changing it.

Field Setting	Set To	Description
20-11	-2	Low ambient temp setting for optimisation.
20-12	+15	High ambient temp setting for optimisation.
20-21	48°C	Maximum flow temperature for heating circuit 1 at set value of 20-11. This should be set to the designed flow temperature used to calculate the size of the radiators. If the radiators have been sized by Joule set the temperature to 48°C.
20-22	35°C	Minimum flow temperature for heating circuit 1 at set value of 20-12. This should be set to 35°C.
20-91	1	This tells the system to use the run signal from Zone 1. Not Use Recommended-Use(Signal only ON/OFF) Use(Signal ON/OFF) or WL Interlink OFF(Water Pump1) Use(Signal ON/OFF) or WL Interlink OFF(Water Pump2) Use(Signal ON/OFF) or WL Interlink OFF(Water Pump3)
30-11	1	Tells the unit it has a cylinder connected.
30-25	200L cyl.=50min 300L cyl.=90 min	Maximum cylinder heating time from heat pump before turning back to heating zones.
30-32	200L cyl.=50min 300L cyl.=90min	Maximum cylinder heating time from heat pump before turning on immersion to support it.
30-42	T (Tuesday)	Legionella function activates on this day.
30-43	3am	Legionella function activates on this hour.
30-44	60°C	Legionella function raises water temp to this.
30-51	-	Enables the timer for DHW Boost mode.
30-52	60	Should automatically be set to 60 minutes, this is the max time in boost mode before the unit reverts back to normal operation.
30-83	3	Booster Heater Capacity

Once the parameters have been set, push the Escape key once and the controller should revert back to just showing the time.

# AS Heat Pump & Smart Plumb Pre-plumbed 2 Heating & 1 Domestic Hot Water

## Mechanical Diagram

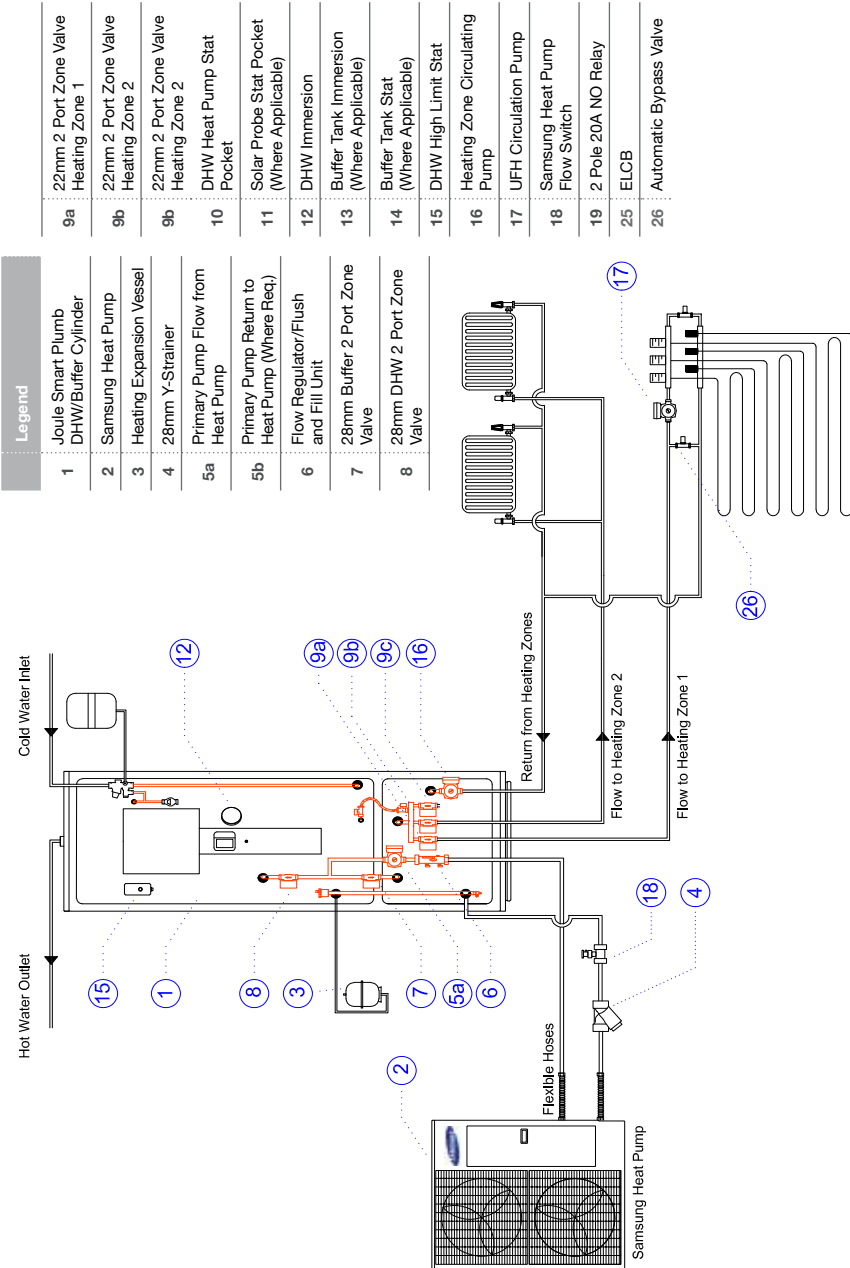

# Electrical Diagram

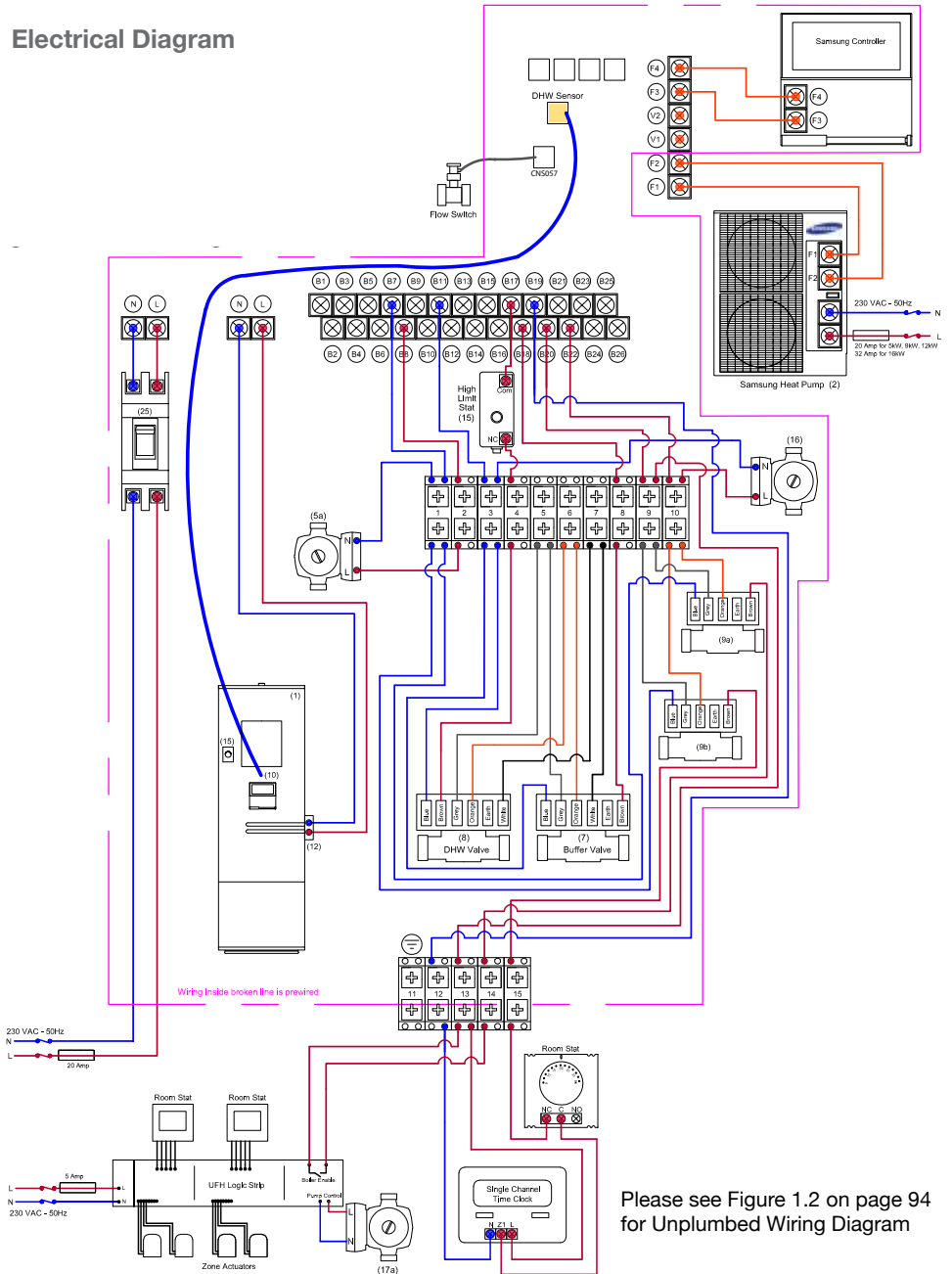

Please see Figure 1.2 on page 94 for Unplumbed Wiring Diagram

## Field Setting Parameters

### How to enter Service Mode

Using two hands, **push and hold** the up and down arrows for **10 seconds**



Password will appear, the password is **0202**

Use arrows to enter password

### Accessing And Adjusting The Field Settings

Use  to highlight field setting value



Push  arrow to enter

Use   arrows to select sub menu required.

Example for weather comp and heating flow high light 20 – water law

Push  arrow to enter sub menu

You will see the individual settings within this menu.

Use  and  to set FSV

Example 2011 Low set is 15, High set is 2.0

Once set push **OK** and Saving FSV will be displayed.

You will then **return** to the heat sub menu.

You can then use  and  arrows to highlight other heat settings push right arrow to enter.

To go back to FSV menu use the back key and you can then move to other sub menus such as DHW.

To **exit FSV mode** push  until you return to the front Screen.

## Field Setting Parameters For Smart Plumb Cylinder Units - 3 Zone



If you set a field setting and go back to check it, it will not have changed. The field setting does not get written to the PCB unless you push SET after changing it.

Field Setting	Set To	Description
20-11	-2	Low ambient temp setting for optimisation.
20-12	+15	High ambient temp setting for optimisation.
20-21	40°C	Maximum flow temperature for heating circuit 1 at set value of 20-11. This should be set to the designed flow temperature used to calculate the size of the underfloor heating system. If the underfloor has been designed and supplied by Joule set the temperature to 40°C.
20-22	35°C	Minimum flow temperature for heating circuit 1 at set value of 20-12. This should be set to 35°C.
20-31	48°C	Maximum flow temperature for heating circuit 2 at set value of 20-11. This should be set to the designed flow temperature used to calculate the size of the radiators. If the radiators have been sized by Joule set the temperature to 48°C.
20-32	35°C	Minimum flow temperature for heating circuit 2 at set value of 20-12. This should be set to 35°C.
20-91	1	External Run input for Zone 1 ( Room stat ) (Not Use, Recommended-Use (Signal only ON/OFF), Use(Signal ON/OFF) or WL Interlink OFF(Water Pump1) Use(Signal ON/OFF) or WL Interlink OFF(Water Pump2) Use(Signal ON/OFF) or WL Interlink OFF(Water Pump3)
20-92	1	External Run input for Zone 1 ( Room stat ) (Not Use, Recommended-Use (Signal only ON/OFF), Use(Signal ON/OFF) or WL Interlink OFF(Water Pump1) Use(Signal ON/OFF) or WL Interlink OFF(Water Pump2) Use(Signal ON/OFF) or WL Interlink OFF(Water Pump3)
30-11	1	Tells the unit it has a cylinder connected.
30-25	200L cyl.=50min 300L cyl.=90 min	Maximum cylinder heating time from heat pump before turning back to heating zones.
30-32	200L cyl.=50min 300L cyl.=90min	Maximum cylinder heating time from heat pump before turning on immersion to support it.
30-42	T (Tuesday)	Legionella function activates on this day.
30-43	3am	Legionella function activates on this hour.
30-44	60°C	Legionella function raises water temp to this.
30-51	-	Enables the timer for DHW Boost mode.
30-52	60	Should automatically be set to 60 minutes, this is the max time in boost mode before the unit reverts back to normal operation.
30-83	3	Booster Heater capacity

Once the parameters have been set, push the Escape key once and the controller should revert back to just showing the time.

## AS Heat Pump & Pre-plumbed Hi-Gain Indirect 1 Heating & 1 Domestic Hot Water

### Mechanical Diagram

Legend	
1	Joule Smart Plumb DHW/Buffer Cylinder
2	Samsung Heat Pump
3	Heating Expansion Vessel
4	28mm Y-Strainer
5a	Primary Pump Flow from Heat Pump
5b	Primary Pump Return to Heat Pump (Where Req.)

6	Flow Regulator/Flush and Fill Unit
7	28mm Buffer 2 Port Zone Valve
8	28mm DHW 2 Port Zone Valve
9a	22mm 2 Port Zone Valve Heating Zone 1
9b	22mm 2 Port Zone Valve Heating Zone 2
9c	22mm 2 Port Zone Valve Heating Zone 3
10	DHW Heat Pump Stat Pocket
11	Solar Probe Stat Pocket (Where Applicable)
12	DHW Immersion
13	Buffer Tank Immersion (Where Applicable)
14	Buffer Tank Stat (Where Applicable)
15	DHW High Limit Stat
16	Heating Zone Circulating Pump
17	UFH Circulation Pump
18	Samsung Heat Pump Flow Switch
19	2 Pole 20A NO Relay
25	ELCB
26	Automatic Bypass Valve

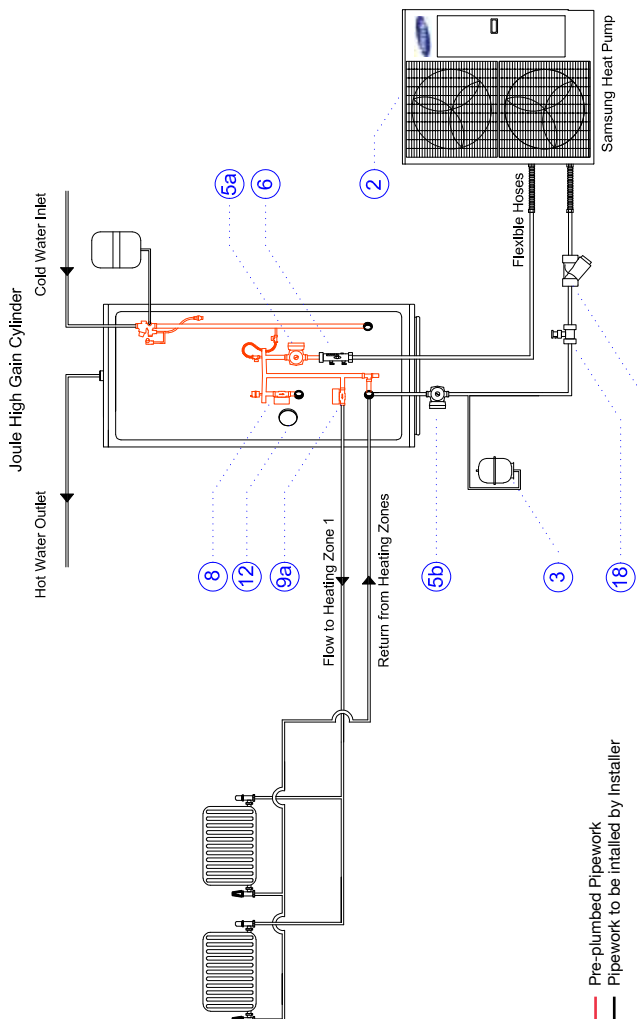

— Pre-plumbed Pipework  
 — Pipework to be installed by Installer

# Electrical Diagram

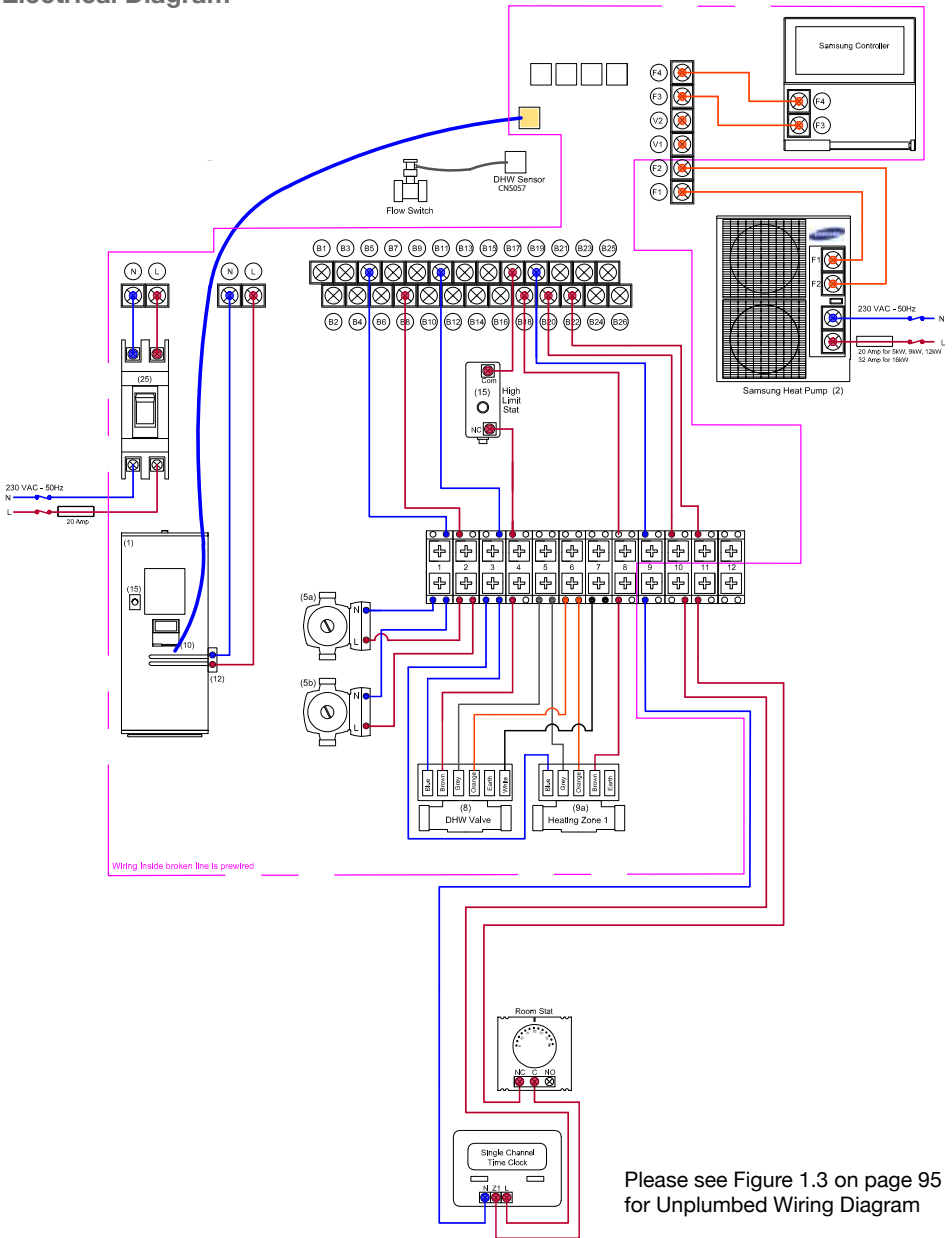

## Field Setting Parameters

### How to enter Service Mode

Using two hands, **push and hold** the up and down arrows for **10 seconds**



Password will appear, the password is **0202**

Use arrows to enter password

### Accessing And Adjusting The Field Settings

Use  to highlight field setting value



Push  arrow to enter

Use   arrows to select sub menu required.

Example for weather comp and heating flow high light 20 – water law

Push  arrow to enter sub menu

You will see the individual settings within this menu.

Use  and  to set FSV

Example 2011 Low set is 15, High set is 2.0

Once set push **OK** and Saving FSV will be displayed.

You will then **return** to the heat sub menu.

You can then use  and  arrows to highlight other heat settings push right arrow to enter.

To go back to FSV menu use the back key and you can then move to other sub menus such as DHW.

To **exit FSV mode** push  until you return to the front Screen.



## Field Setting Parameters For Smart Plumb Cylinder Units - 2 Zone



If you set a field setting and go back to check it, it will not have changed. The field setting does not get written to the PCB unless you push SET after changing it.

Field Setting	Set To	Description
20-11	-2	Low ambient temp setting for optimisation.
20-12	+15	High ambient temp setting for optimisation.
20-21	48°C	Maximum flow temperature for heating circuit 1 at set value of 20-11. This should be set to the designed flow temperature used to calculate the size of the radiators. If the radiators have been sized by Joule set the temperature to 48°C.
20-22	35°C	Minimum flow temperature for heating circuit 1 at set value of 20-12. This should be set to 35°C.
20-91	1	External Run input for Zone 1 ( Room stat ) (Not Use, Recommended-Use (Signal only ON/OFF), Use(Signal ON/OFF) or WL Interlink OFF(Water Pump1) Use(Signal ON/OFF) or WL Interlink OFF(Water Pump2) Use(Signal ON/OFF) or WL Interlink OFF(Water Pump3)
30-11	1	Tells the unit it has a cylinder connected.
30-25	200L cyl.=50min 300L cyl.=90min	Maximum cylinder heating time from heat pump before turning back to heating zones.
30-32	200L cyl.=50min 300L cyl.=90min	Maximum cylinder heating time from heat pump before turning on immersion to support it.
30-42	T (Tuesday)	Legionella function activates on this day.
30-43	3am	Legionella function activates on this hour.
30-44	60°C	Legionella function raises water temp to this.
30-51	-	Enables the timer for DHW Boost mode.
30-52	60	Should automatically be set to 60 minutes, this is the max time in boost mode before the unit reverts back to normal operation.
30-83	3	Booster Heater Capacity

Once the parameters have been set, push the Escape key once and the controller should revert back to just showing the time.

## AS Heat Pump & Pre-plumbed Hi-Gain Indirect 2 Heating & 1 Domestic Hot Water

### Mechanical Diagram

Legend	
1	Joule Smart Plumb DHW/Buffer Cylinder
2	Samsung Heat Pump
3	Heating Expansion Vessel
4	28mm Y-Strainer
5a	Primary Pump Flow from Heat Pump
5b	Primary Pump Return to Heat Pump (Where Req.)

6	Flow Regulator/Flush and Fill Unit
7	28mm Buffer 2 Port Zone Valve
8	28mm DHW 2 Port Zone Valve
9a	22mm 2 Port Zone Valve Heating Zone 1
9b	22mm 2 Port Zone Valve Heating Zone 2
9c	22mm 2 Port Zone Valve Heating Zone 3
10	DHW Heat Pump Stat Pocket
11	Solar Probe Stat Pocket (Where Applicable)
12	DHW Immersion
13	Buffer Tank Immersion (Where Applicable)
14	Buffer Tank Stat (Where Applicable)
15	DHW High Limit Stat
16	Heating Zone Circulating Pump
17	UFH Circulation Pump
18	Samsung Heat Pump Flow Switch
19	2 Pole 20A NO Relay
25	ELOB
26	Automatic Bypass Valve

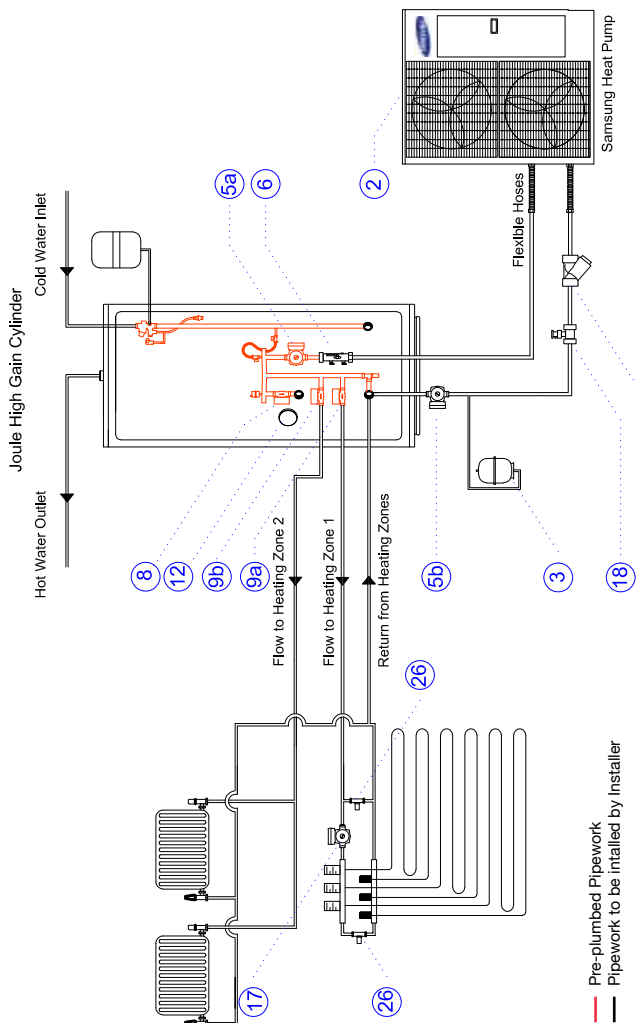

# Electrical Diagram

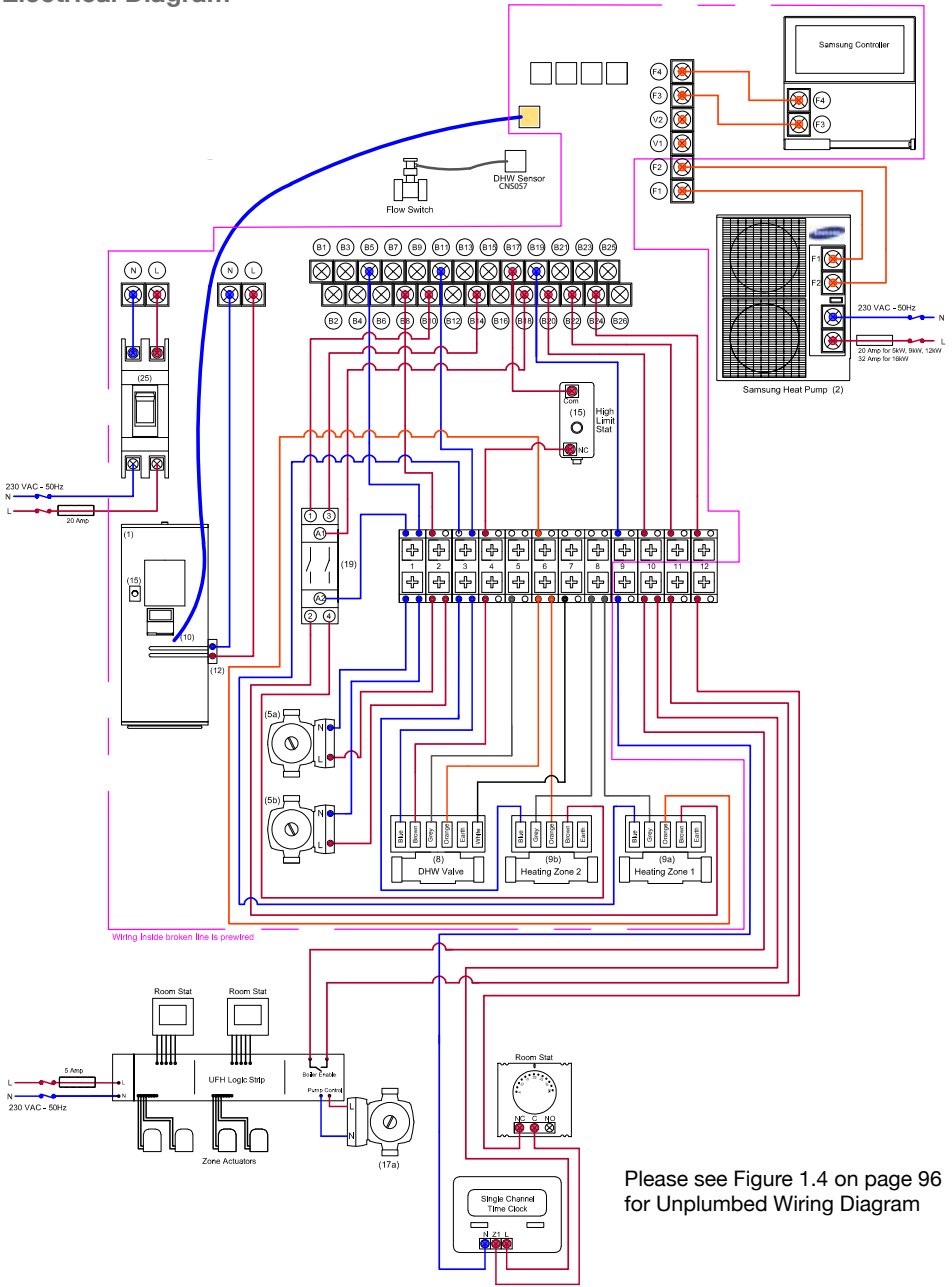

Please see Figure 1.4 on page 96 for Unplumbed Wiring Diagram

# Field Setting Parameters

## How to enter Service Mode

Using two hands, **push and hold** the up and down arrows for **10 seconds**



Password will appear, the password is **0202**

Use arrows to enter password

## Accessing And Adjusting The Field Settings

Use  to highlight field setting value



Push  arrow to enter

Use   arrows to select sub menu required.

Example for weather comp and heating flow high light 20 – water law

Push  arrow to enter sub menu

You will see the individual settings within this menu.

Use  and  to set FSV

Example 2011 Low set is 15, High set is 2.0

Once set push **OK** and Saving FSV will be displayed.

You will then **return** to the heat sub menu.

You can then use  and  arrows to highlight other heat settings push right arrow to enter.

To go back to FSV menu use the back key and you can then move to other sub menus such as DHW.

To **exit FSV mode** push  until you return to the front Screen.

## Field Setting Parameters For Smart Plumb Cylinder Units - 3 Zone



If you set a field setting and go back to check it, it will not have changed. The field setting does not get written to the PCB unless you push SET after changing it.

Field Setting	Set To	Description
20-11	-2	Low ambient temp setting for optimisation.
20-12	+15	High ambient temp setting for optimisation.
20-21	40°C	Maximum flow temperature for heating circuit 1 at set value of 20-11. This should be set to the designed flow temperature used to calculate the size of the underfloor heating system. If the underfloor has been designed and supplied by Joule set the temperature to 40°C.
20-22	35°C	Minimum flow temperature for heating circuit 1 at set value of 20-12. This should be set to 35°C.
20-31	48°C	Maximum flow temperature for heating circuit 2 at set value of 20-11. This should be set to the designed flow temperature used to calculate the size of the radiators. If the radiators have been sized by Joule set the temperature to 48°C.
20-32	35°C	Minimum flow temperature for heating circuit 2 at set value of 20-12. This should be set to 35°C.
20-91	1	External Run input for Zone 1 ( Room stat ) (Not Use, Recommended-Use (Signal only ON/OFF), Use(Signal ON/OFF) or WL Interlink OFF(Water Pump1) Use(Signal ON/OFF) or WL Interlink OFF(Water Pump2) Use(Signal ON/OFF) or WL Interlink OFF(Water Pump3)
20-92	1	External Run input for Zone 1 ( Room stat ) (Not Use, Recommended-Use (Signal only ON/OFF), Use(Signal ON/OFF) or WL Interlink OFF(Water Pump1) Use(Signal ON/OFF) or WL Interlink OFF(Water Pump2) Use(Signal ON/OFF) or WL Interlink OFF(Water Pump3)
30-11	1	Tells the unit it has a cylinder connected.
30-25	200L cyl.=50min 300L cyl.=90min	Maximum cylinder heating time from heat pump before turning back to heating zones.
30-32	200L cyl.=50min 300L cyl.=90min	Maximum cylinder heating time from heat pump before turning on immersion to support it.
30-42	T (Tuesday)	Legionella function activates on this day.
30-43	3am	Legionella function activates on this hour.
30-44	60°C	Legionella function raises water temp to this.
30-51	-	Enables the timer for DHW Boost mode.
30-52	60	Should automatically be set to 60 minutes, this is the max time in boost mode before the unit reverts back to normal operation.
30-83	3	Booster Heater Capacity

Once the parameters have been set, push the Escape key once and the controller should revert back to just showing the time.

# 2x AS Heat Pump & Smart Plumb Pre-plumbed 2 Heating & 1 Domestic Hot Water

## Mechanical Diagram

6	Flow Regulator/Flush and Fill Unit
7	28mm Buffer 2 Port Zone Valve
8	28mm DHW 2 Port Zone Valve
9a	22mm 2 Port Zone Valve Heating Zone 1
9b	22mm 2 Port Zone Valve Heating Zone 2
9c	22mm 2 Port Zone Valve Heating Zone 3
10	DHW Heat Pump Stat Pocket
11	Solar Probe Stat Pocket (Where Applicable)
12	DHW Immersion
13	Buffer Tank Immersion (Where Applicable)
14	Buffer Tank Stat (Where Applicable)
15	DHW High Limit Stat
16	Heating Zone Circulating Pump
17	UFH Circulation Pump
18	Samsung Heat Pump Flow Switch
19	2 Pole 20A NO Relay
25	ELCB
26	Automatic Bypass Valve

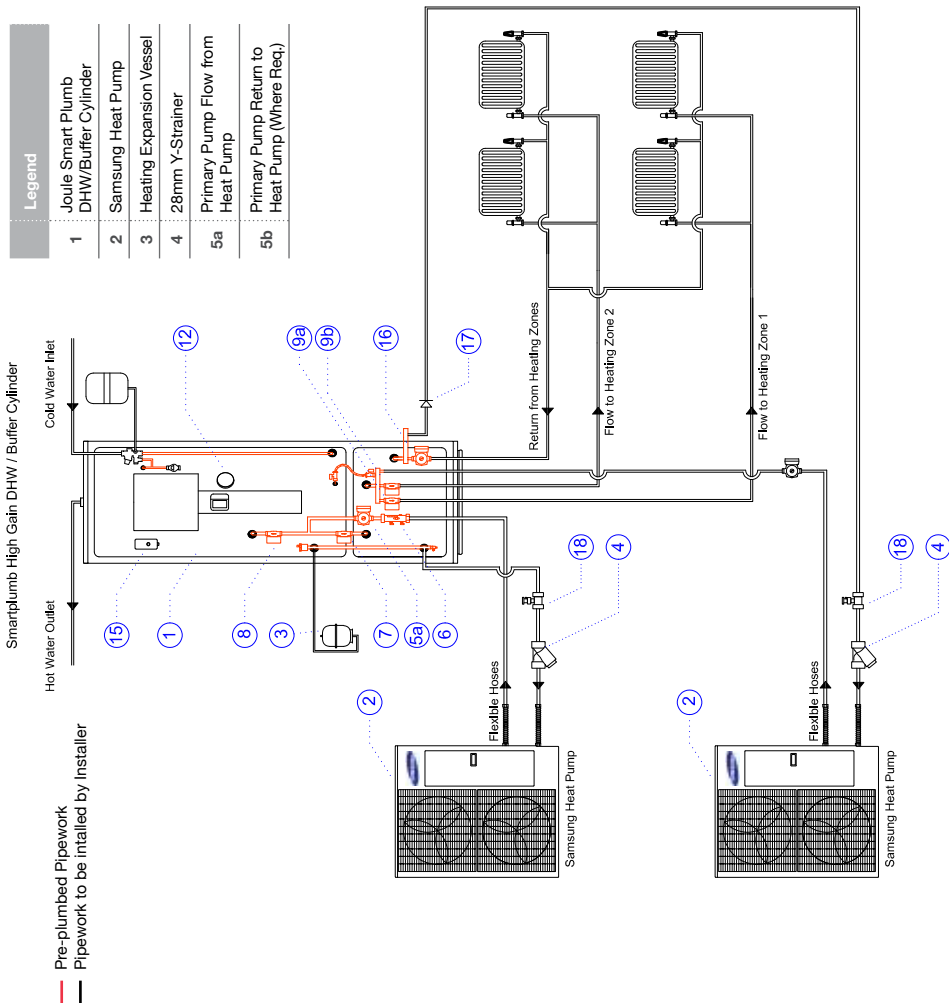



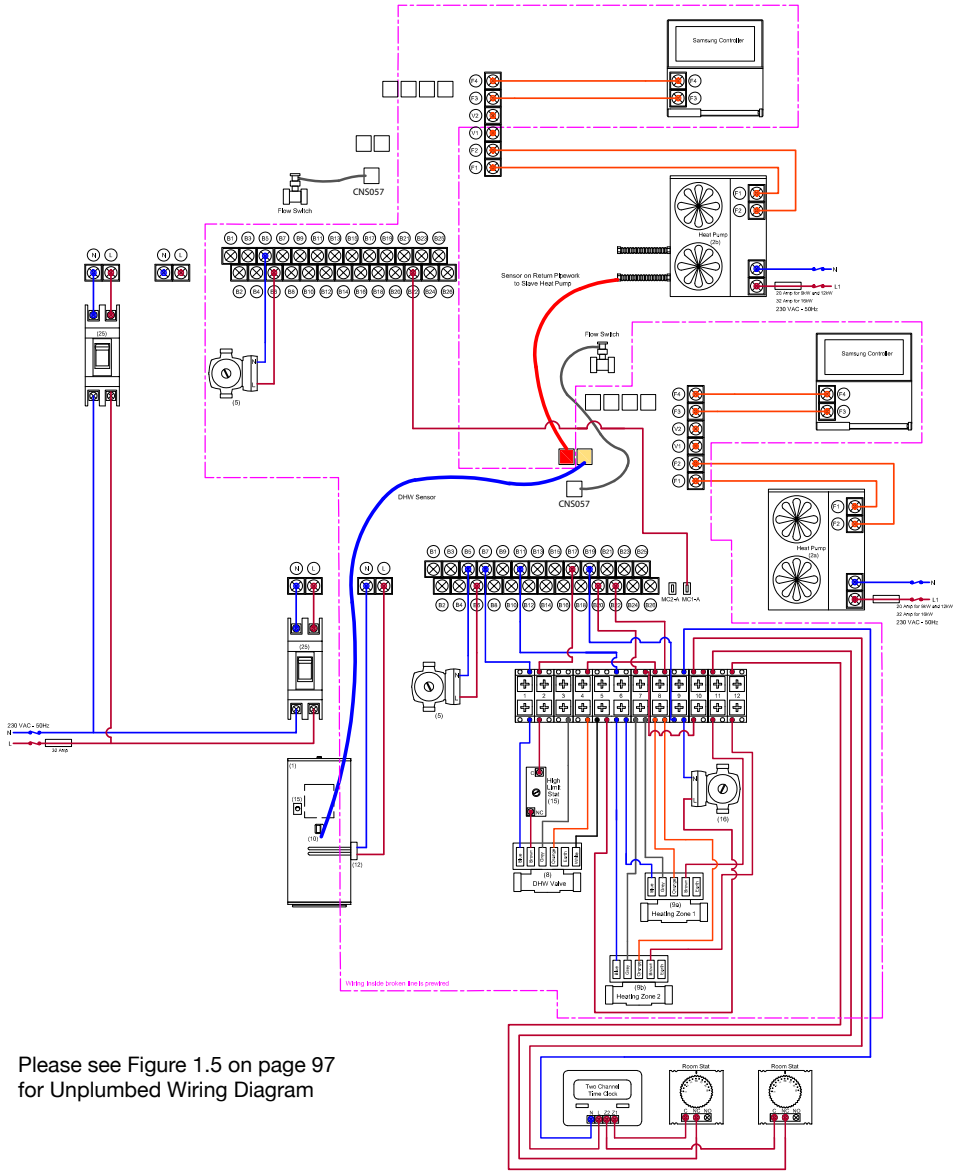





# Electrical Diagram



Please see Figure 1.5 on page 97 for Unplumbed Wiring Diagram

# Field Setting Parameters

## Accessing And Adjusting The Field Settings

1. To access the field settings push and hold the down arrow and the set key together until the display shows "10".
2. Push the  arrow once to change **10** to **20**.
3. Push the  arrow once so the screen shows **20-11**.
4. Push the  arrow again and the value for **20-11** is shown, use the  and  arrows to change this value to the desired one.
5. Once the value is changed you must push the **Set** key otherwise the change is not saved. Push the **Set**  to save and a swirling line will appear, this indicated that the unit is saving the change.
6. Push the  arrow so that **20-11** flashes, then push the  arrow to change to **20-12**, repeat the above process for each parameter that needs to be adjusted.
7. To move up a level in the menu system (Change from **20** codes to **30** codes) push the **Left** arrow until the screen goes back to the initial setting i.e 20. Use the **Up** arrow to change to **30**, then push the  arrow to enter the menu (**30-11**)
8. Once you have completed adjusting the parameters, push the **Esc** key to return to the normal controller screen.



## Field Setting Parameters For Smart Plumb Cylinder Units - 3 Zone



If you set a field setting and go back to check it, it will not have changed. The field setting does not get written to the PCB unless you push SET after changing it.

Field Setting	Set To	Description
20-11	-2	Low ambient temp setting for optimisation.
20-12	+15	High ambient temp setting for optimisation.
20-21	40°C	Maximum flow temperature for heating circuit 1 at set value of 20-11. This should be set to the designed flow temperature used to calculate the size of the underfloor heating system. If the underfloor has been designed and supplied by Joule set the temperature to 40°C.
20-22	35°C	Minimum flow temperature for heating circuit 1 at set value of 20-12. This should be set to 35°C.
20-31	48°C	Maximum flow temperature for heating circuit 2 at set value of 20-11. This should be set to the designed flow temperature used to calculate the size of the radiators. If the radiators have been sized by Joule set the temperature to 48°C.
20-32	35°C	Minimum flow temperature for heating circuit 2 at set value of 20-12. This should be set to 35°C.
20-91	1	External Run input for Zone 1 ( Room stat ) (Not Use, Recommended-Use (Signal only ON/OFF), Use(Signal ON/OFF) or WL Interlink OFF(Water Pump1) Use(Signal ON/OFF) or WL Interlink OFF(Water Pump2) Use(Signal ON/OFF) or WL Interlink OFF(Water Pump3)
20-92	1	External Run input for Zone 1 ( Room stat ) (Not Use, Recommended-Use (Signal only ON/OFF), Use(Signal ON/OFF) or WL Interlink OFF(Water Pump1) Use(Signal ON/OFF) or WL Interlink OFF(Water Pump2) Use(Signal ON/OFF) or WL Interlink OFF(Water Pump3)
30-11	1	Tells the unit it has a cylinder connected.
30-25	200L cyl.=50min 300L cyl.=90min	Maximum cylinder heating time from heat pump before turning back to heating zones.
30-32	200L cyl.=50min 300L cyl.=90min	Maximum cylinder heating time from heat pump before turning on immersion to support it.
30-42	T (Tuesday)	Legionella function activates on this day.
30-43	3am	Legionella function activates on this hour.
30-44	60°C	Legionella function raises water temp to this.
30-51	-	Enables the timer for DHW Boost mode.
30-52	60	Should automatically be set to 60 minutes, this is the max time in boost mode before the unit reverts back to normal operation.
30-83	3	Booster Heater Capacity

Once the parameters have been set, push the Escape key once and the controller should revert back to just showing the time.

# AS Heat Pump & Smart Plumb Pre-plumbed & Bivalent Boiler 2 Heating & 1 Domestic Hot Water

## Mechanical Diagram

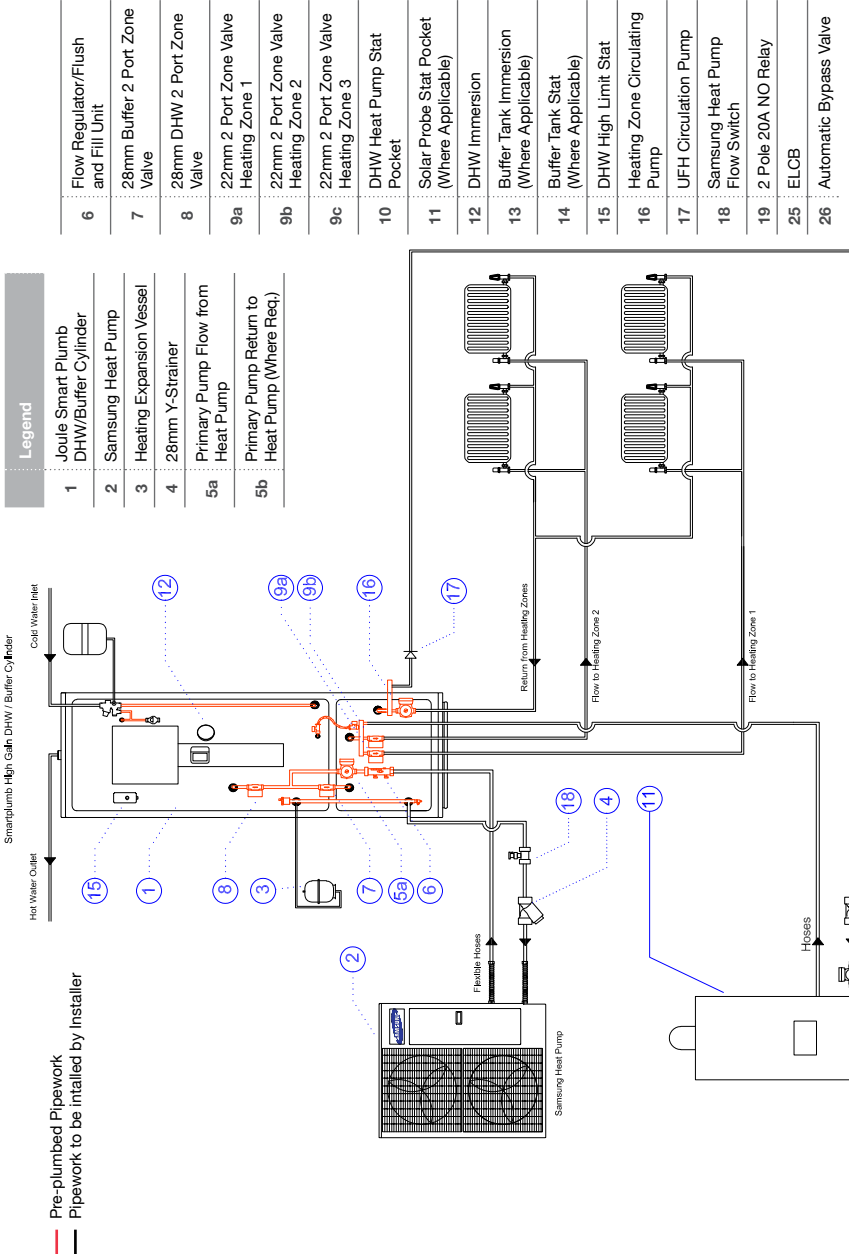

# Electrical Diagram

# Field Setting Parameters

## How to enter Service Mode

Using two hands, **push and hold** the up and down arrows for **10 seconds**



Password will appear, the password is **0202**

Use arrows to enter password

## Accessing And Adjusting The Field Settings

Use  to highlight field setting value



Push  arrow to enter

Use   arrows to select sub menu required.

Example for weather comp and heating flow high light 20 – water law

Push  arrow to enter sub menu

You will see the individual settings within this menu.

Use  and  to set FSV

Example 2011 Low set is 15, High set is 2.0

Once set push **OK** and Saving FSV will be displayed.

You will then **return** to the heat sub menu.

You can then use  and  arrows to highlight other heat settings push right arrow to enter.

To go back to FSV menu use the back key and you can then move to other sub menus such as DHW.

To **exit FSV mode** push  until you return to the front Screen.

## Field Setting Parameters For Smart Plumb Cylinder Units - 3 Zone



If you set a field setting and go back to check it, it will not have changed. The field setting does not get written to the PCB unless you push SET after changing it.

Field Setting	Set To	Description
20-11	-2	Low ambient temp setting for optimisation.
20-12	+15	High ambient temp setting for optimisation.
20-21	40°C	Maximum flow temperature for heating circuit 1 at set value of 20-11. This should be set to the designed flow temperature used to calculate the size of the underfloor heating system. If the underfloor has been designed and supplied by Joule set the temperature to 40°C.
20-22	35°C	Minimum flow temperature for heating circuit 1 at set value of 20-12. This should be set to 35°C.
20-31	48°C	Maximum flow temperature for heating circuit 2 at set value of 20-11. This should be set to the designed flow temperature used to calculate the size of the radiators. If the radiators have been sized by Joule set the temperature to 48°C.
20-32	35°C	Minimum flow temperature for heating circuit 2 at set value of 20-12. This should be set to 35°C.
20-91	1	External Run input for Zone 1 ( Room stat ) (Not Use, Recommended-Use (Signal only ON/OFF), Use(Signal ON/OFF) or WL Interlink OFF(Water Pump1) Use(Signal ON/OFF) or WL Interlink OFF(Water Pump2) Use(Signal ON/OFF) or WL Interlink OFF(Water Pump3)
20-92	1	External Run input for Zone 1 ( Room stat ) (Not Use, Recommended-Use (Signal only ON/OFF), Use(Signal ON/OFF) or WL Interlink OFF(Water Pump1) Use(Signal ON/OFF) or WL Interlink OFF(Water Pump2) Use(Signal ON/OFF) or WL Interlink OFF(Water Pump3)
30-11	1	Tells the unit it has a cylinder connected.
30-25	200L cyl.=50min 300L cyl.=90min	Maximum cylinder heating time from heat pump before turning back to heating zones.
30-32	200L cyl.=50min 300L cyl.=90min	Maximum cylinder heating time from heat pump before turning on immersion to support it.
30-42	T (Tuesday)	Legionella function activates on this day.
30-43	3am	Legionella function activates on this hour.
30-44	60°C	Legionella function raises water temp to this.
30-51	-	Enables the timer for DHW Boost mode.
30-52	60	Should automatically be set to 60 minutes, this is the max time in boost mode before the unit reverts back to normal operation.
30-83	3	Booster Heater Capacity

Once the parameters have been set, push the Escape key once and the controller should revert back to just showing the time.

# Smart Plumb Compact Installation 2 Heating & 1 Domestic Hot Water

## Mechanical Schematic - 3 Zone

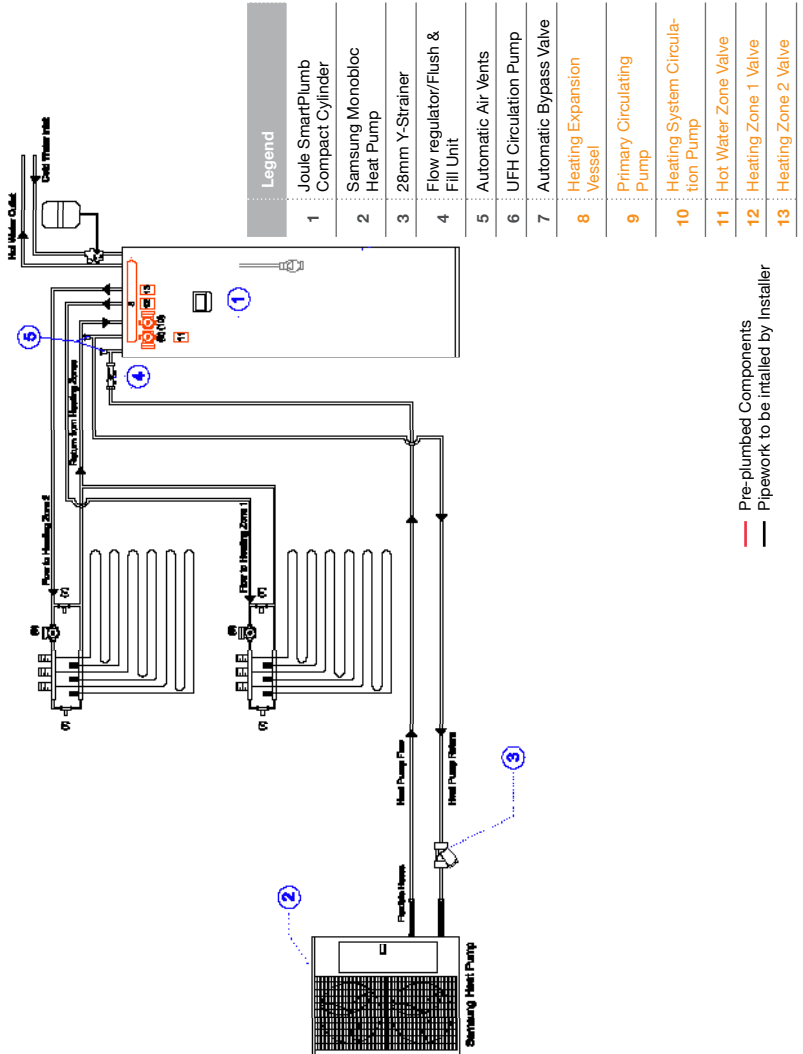

— Pre-plumbed Components  
— Pipework to be installed by Installer



After servicing, re-secure all cables using straps provided. Reconnect main remote controller cable to its relay connector. Replace front panel and re-secure screws at base

# Smart Plumb Compact Installation

## 2 Heating & 1 Domestic Hot Water

### Electrical Schematic - 3 Zone

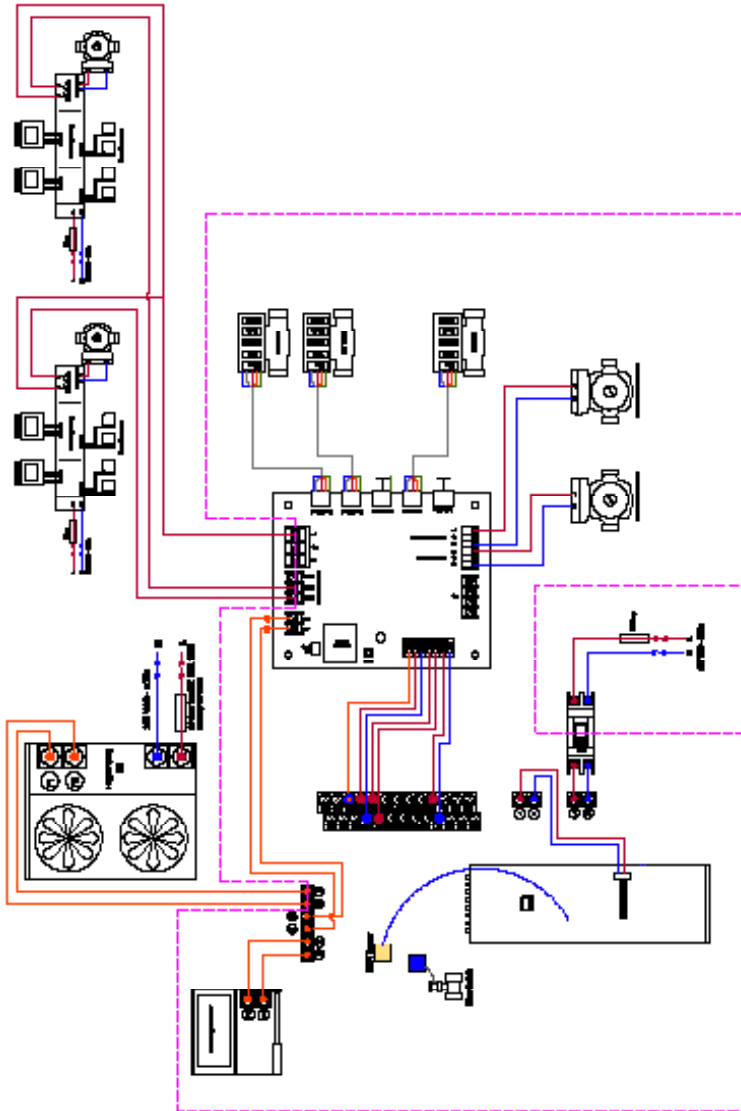

Wiring inside broken line is prewired

# Smart Plumb Compact Installation 3 Heating & 1 Domestic Hot Water

## Mechanical Schematic - 4 Zone

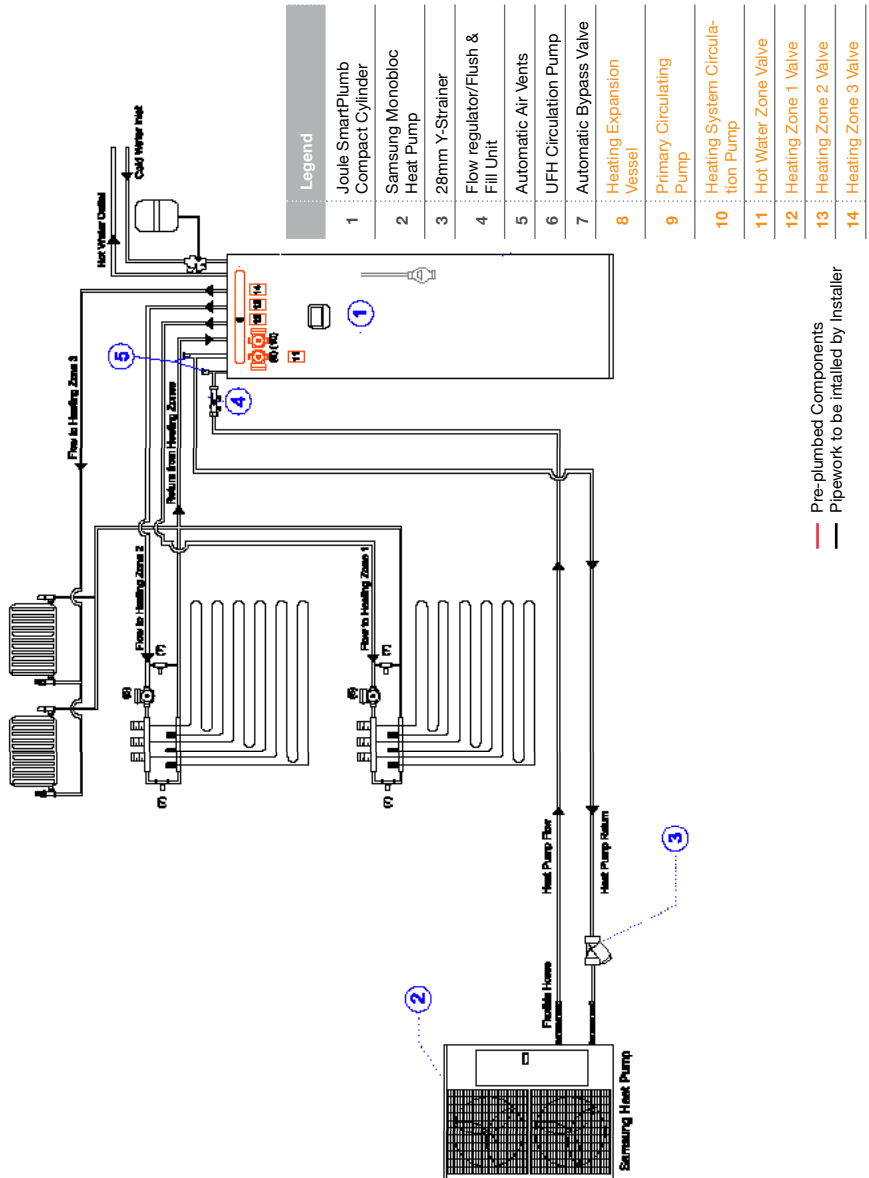



# Smart Plumb Compact Installation 3 Heating & 1 Domestic Hot Water

## Electrical Schematic - 4 Zone

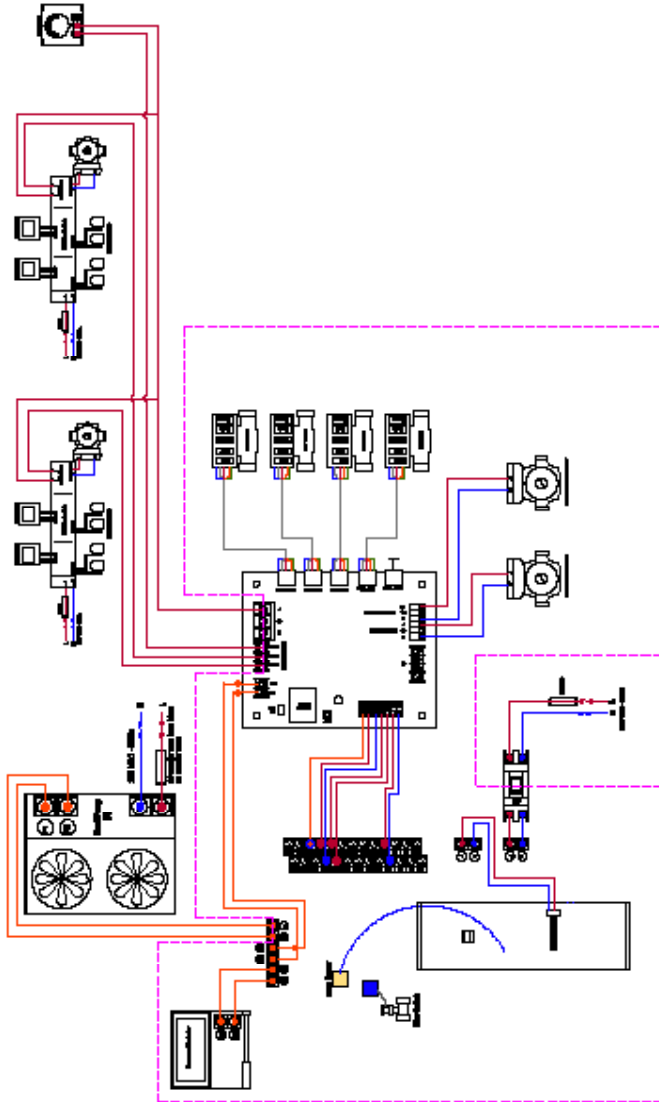

Wiring inside broken line is prewired

# Smart Plumb Compact Installation Transport and Handling

## Transport and Handling

Care must be taken when transporting, storing and installing the equipment:

At least two people should lift the cylinder to prevent injuries.

The cylinder must be stored in a dry area and must never be dropped during handling.

Packaging should only be removed at the installation location.

The cylinder must be installed on a level floor with the required load bearing capability. Installation, servicing, maintenance and repair must be carried out by a competent person.

The Smart Plumb Compact unit is delivered fully packaged and fixed to a wooden pallet base. Care should be taken when transporting the cylinder unit ensuring that the casing is not damaged by impact.

Do not remove the protective packaging until the cylinder unit has reached its final location. This will help protect the structure and control panel.



**The cylinder unit must be transported in an upright position only.**

# Smart Plumb Compact Installation Transport and Handling

## Measurements

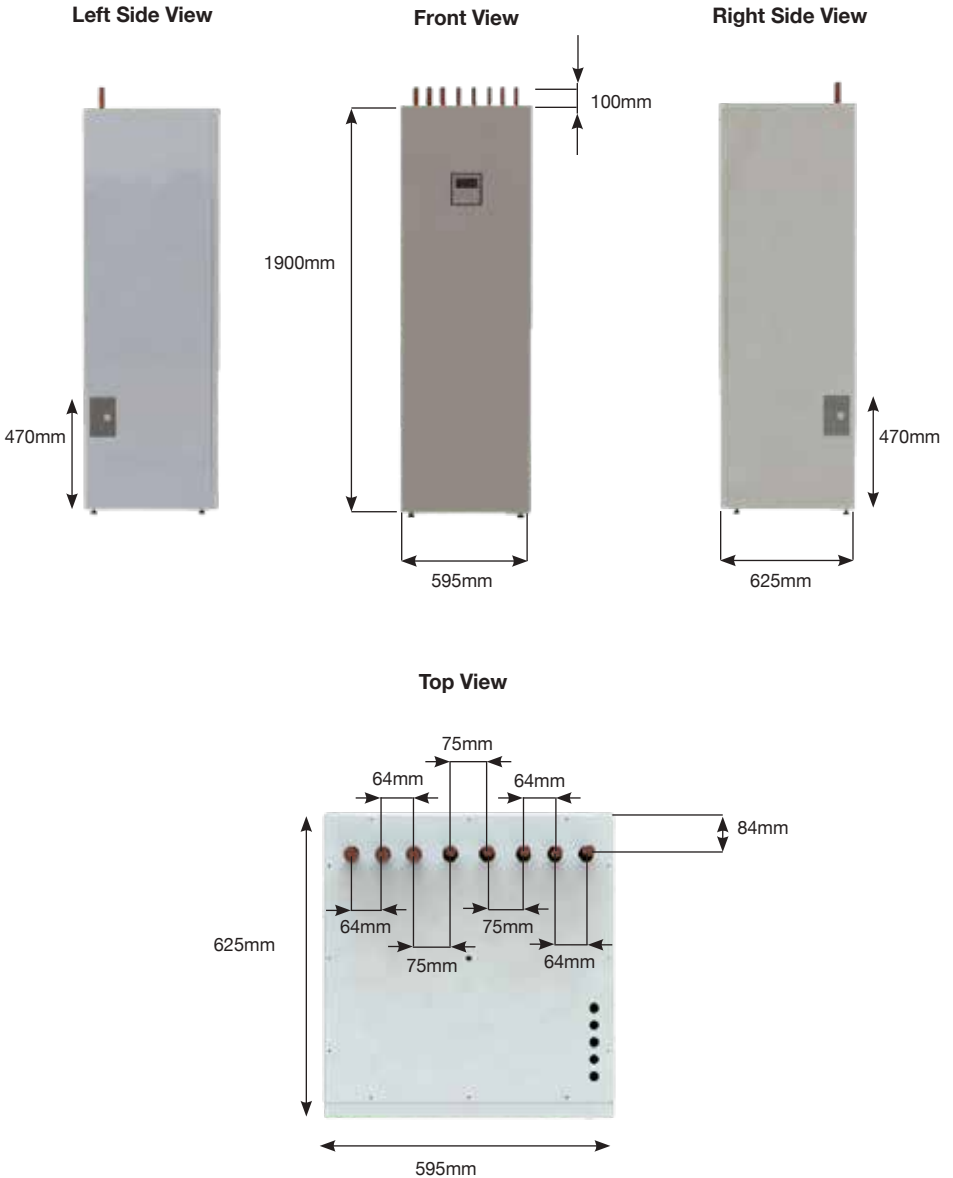

## Smart Plumb Compact Installation Suitable Location

Care should be taken that there is a minimum distance in front of the unit for service and maintenance works to be carried out. Enough access to allow maintenance of the valves should be considered. In addition, the immersion heater is 400mm in length and this distance should be considered to allow withdrawal for servicing if required.

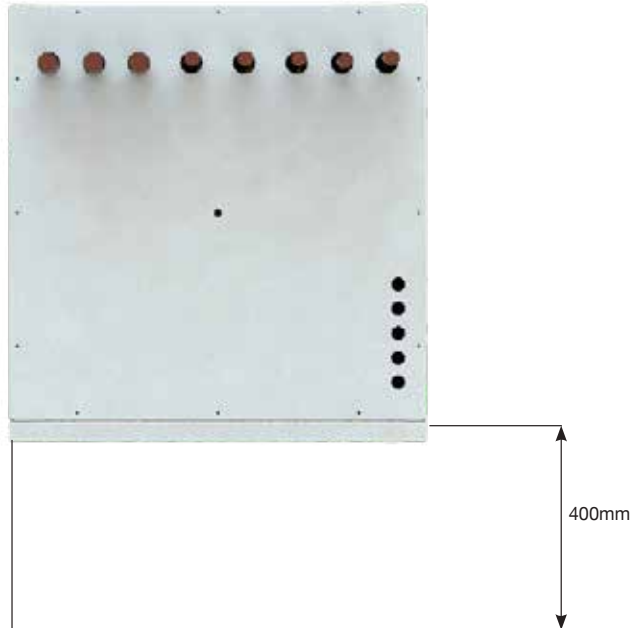

When using the adjustable feet, ensure that the floor is strong enough. Install the cylinder unit where it is not exposed to water/excessive moisture. Particular attention is needed if siting in a garage or outbuilding as the unit should be protected from frost. All exposed pipework must be insulated. The unit must be installed upright on a base capable of supporting its weight when full (please see the technical specification section for weights).

# Smart Plumb Compact Installation Pipe Connections

Reference	Description	Value
A	H.P Flow	28mm
B	H.P Return	28mm
C	Heating Return	28mm
D	Heating Flow Zone 1	22mm
E	Heating Flow Zone 2	22mm
F	Heating Flow Zone 3	22mm
G	Hot Outlet	22mm
H	Cold Inlet	22mm

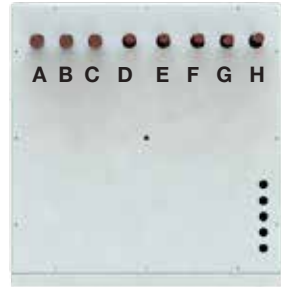

All the pipework connections are off the top section of the casing. Upon filling and commissioning, ensure all connections are completely watertight.

## Electrical Entry Point

A lack of safety devices can lead to potentially fatal injuries, all necessary safety devices must be installed correctly in the system. The hot and cold pipework are required to be correctly bonded and connected to the earth line.

All electrical wiring must be carried out by a qualified electrician and be installed in accordance with current I.E.E Wiring Regulations

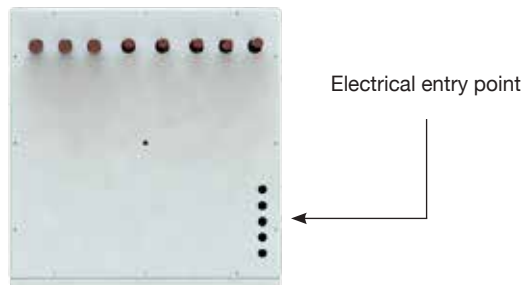

# Smart Plumb Compact Installation Temperature & Pressure Relief Valve

## Temperature & Pressure Relief Valve Pipework

Before placing the Smart Plumb Cylinder into position take note of the temperature and pressure relief discharge pipe route options. There are left and right points on the Smart Plumb Compact casing to exit the relief pipework.

To access and connect the pipe work follow guidelines listed below

## Remove the Casing Front Panel

1. Remove the two lower screws



2. Slide front panel upwards slightly and open carefully.



3. Disconnect the quick release coupler connecting the main remote controller cable and the control board cable



# Smart Plumb Compact Installation

## Temperature & Pressure Relief Valve

Connect the tundish and route the discharge pipe which must be routed in accordance with Building Regulations - Part G3 of schedule 1.

When operating normally water will not be discharged. Water discharge from the temperature and pressure valve will only occur under fault conditions. The tundish is pre-fitted as shown below.

The discharge pipe (D2) coming from the tundish should terminate in a safe place where there is no risk to persons near the discharge, be of metal and:

- Be at least one pipe size larger than the nominal outlet size of the safety device unless its total equivalent hydraulic resistance exceeds that of a straight pipe 9m long, i.e. discharge pipes between 9m and 18m equivalent resistance length should be at least two sizes larger than the nominal outlet size of the safety device, between 18 and 27m at least 3 sizes larger, and so on.
- Bends must be taken into account in calculating the flow resistance. Refer to diagram 1, Table 1 and the worked example. An alternative approach for sizing discharge pipes would be to follow BS6700 Specification for design, installation, testing and maintenance of services supplying water for domestic use within buildings and their curtilages.
- Be installed with a continuous fall. The discharge must be visible at the final point of discharge.

	G1/2			G3/4			G1		
Min. size of discharge pipe D1	15mm			22mm			28mm		
Min. size of discharge pipeword D2 from tundish	22mm	28mm	35mm	28mm	35mm	42mm	35mm	42mm	54mm
Max. length of straight pipe (no bends or elbows)	Up to 9mm	Up to 18mm	Up to 27mm	Up to 9mm	Up to 18mm	Up to 27mm	Up to 9mm	Up to 18mm	Up to 27mm
Deducts the gure below from the maximum length for each bend or elbow in the discahrge pipe	0.8m	1m	1.4m	1.0m	1.4m	1.7m	1.4m	1.7m	2.3m

Sizing of copper discharge pipe (D2) for a temp, relief valve with a G1/2 outlet size (as supplied)

# Smart Plumb Compact Installation Temperature & Pressure Relief Valve

## Examples of Discharge Arrangements

### Left Side Pipe Exit

Front View



Side View



### Right Side Pipe Exit

Front View



Side View





# Smart Plumb Compact Installation Piping Diagram

## Waterway Schematic

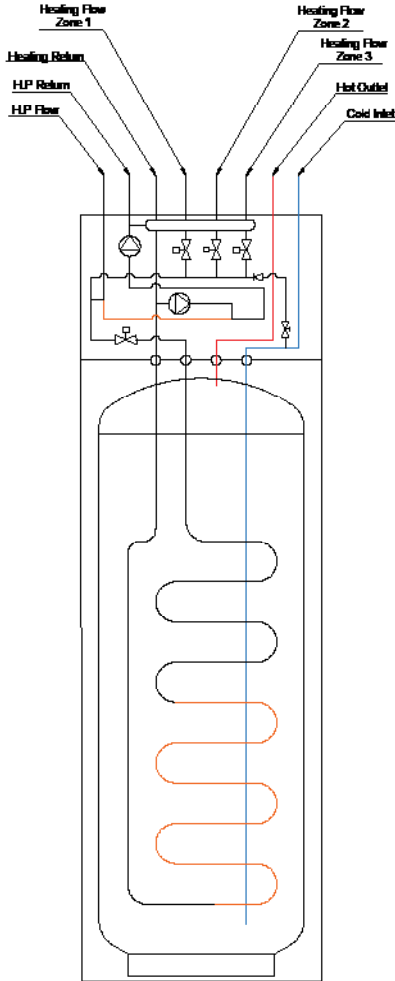

# Smart Plumb Compact Installation Heating System Connection

## Connecting To The Cylinder

If plastic pipes are used, they must be approved temperature resistant to 95°C at a pressure of 10 bar. A thermostatic mixer should be installed in the system to prevent the risk of scalding.

## Heat Pump Primary Connections

Connect the primary connections as shown below. The direction of flow arrow should be towards the primary flow connection. In the Smart Plumb Compact the primary circulating pump is pre-fitted along with the hot water motorised valve.



# Smart Plumb Compact Installation Heating System Connection

## Heating System Pipe Conenctions

Connect the heating zone connections as shown below. In the Smart plumb Compact the heating zone motorised valves are pre-installed along with the heating system expansion vessel. The circulating pump for the heating system is also pre-fitted within the casing.

All heating zone returns should be joined at the cylinder and return via heating return as shown below.

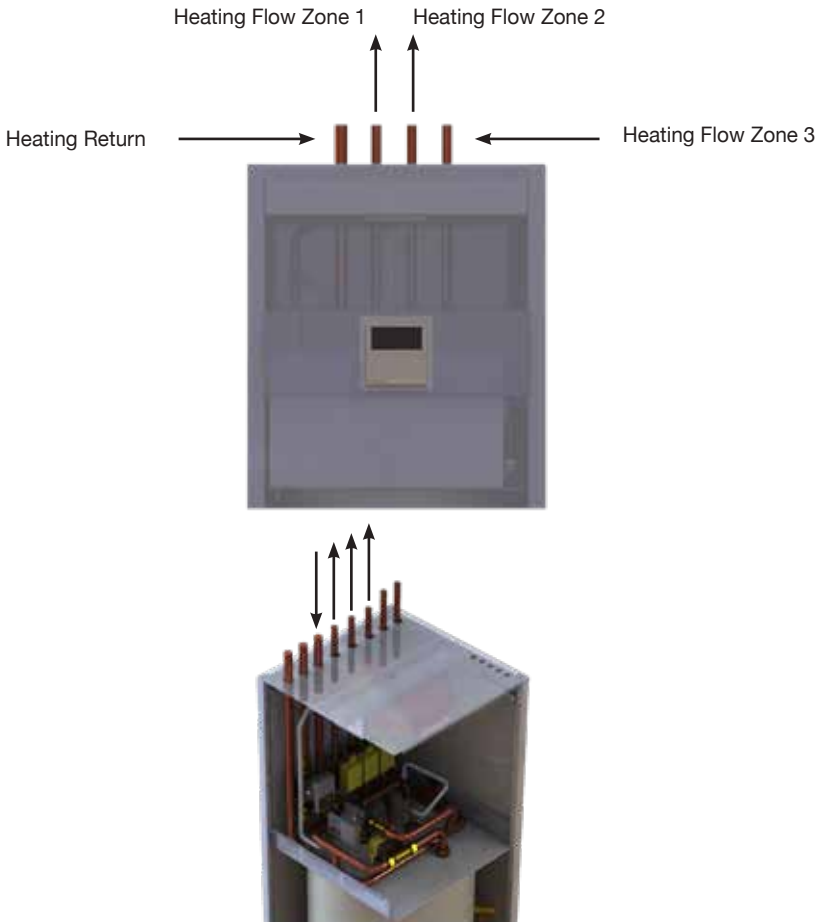

# Smart Plumb Compact Installation

## Potable Pipework

### Fitting the Inlet Control Group

Excess pressure can lead to the cylinder bursting. The inlet control set supplied has an expansion relief valve with a 15mm connection to allow it to be connected to a tundish. Make sure that there is enough space for future maintenance and for connection of the discharge pipe for the expansion relief valve. It is essential that this connection is not covered or closed.

### Balanced Cold Connection

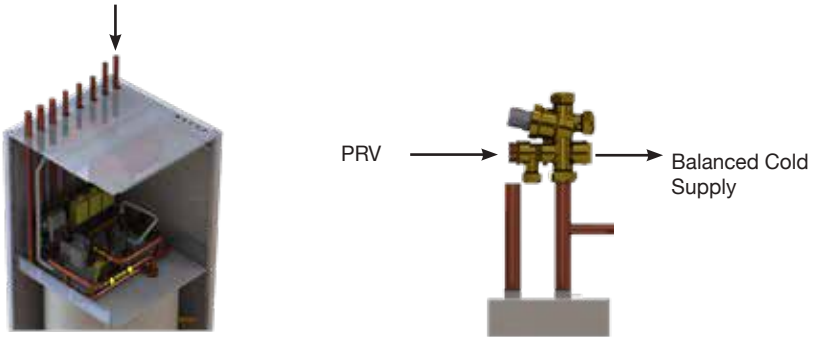

### Potable Expansion Vessel

The expansion vessel receives the increased water volume when expansion takes place as the system heats up and it maintains a positive pressure in the system. The expansion vessel contains a flexible diaphragm, which is initially charged on one side with nitrogen, but can be topped up with air when required. Select a suitable position for the expansion vessel. Mount it to the wall using the bracket provided (0-24L only, 35L and above are floor standing) and hard fix into pipework and insulate. Ensure that the top of the vessel is accessible for servicing. The pipe connecting the expansion vessel to the system should have a diameter of not less than 15mm and must not contain any restrictions.



# Smart Plumb Compact Installation

## Potable Pipework

### Hot Water Outlet

Run the first part of the hot water distribution pipework in 22mm. This can be reduced to 15mm and 10mm as appropriate for the type of tap etc. Your aim should be to reduce the volume of the hot draw-off pipework to a practical minimum so that the time taken for the hot water is as quick as possible. Do not use monobloc mixer tap or showers if the balanced cold connection is not provided. Outlets of this type can back pressurise the unit and result in discharge.



### Secondary Circulation

On larger installations long pipe runs to draw-off points can cause significant volumes of water to be drawn off before an acceptable temperature can be reached. Secondary pumped circulation using a stainless steel or a bronze pump and combined with effective time and temperature controls can overcome this problem. Where secondary return circulation is required the pipework should be run in 15mm pipe. A suitable WRAS approved stainless steel or bronze circulation pump must be used. A check valve must also be installed to prevent back flow

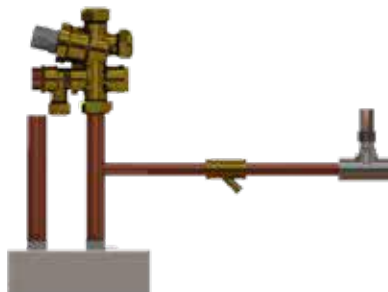

# Smart Plumb Compact Installation Commissioning

## Potable System

First you must ensure that the pressure in the expansion vessel is the same as the setting of the pressure reducing valve i.e. 3 bar (45PSI). The valve is of the Schrader car tyre type.

Check all the connections for water tightness including any factory-made connections such as the immersion heater and the temperature and pressure relief valve.

Prior to filling, open the hot tap furthest away from the cylinder to expel air. Open the cold main isolation valve and allow the unit to fill. Once the cylinder has been fully commissioned it should be heated to its normal operating temperature.

## Heating System

The fill flush and flow meter is an important component of any heat pump system. It is provided in all Joule Heat Pump kits. For all heat pump systems a flow rate of over 16 l/min is required. It provides connections for the fill and flush ports of the heating system flush pump for installation and ongoing servicing. See page 26.

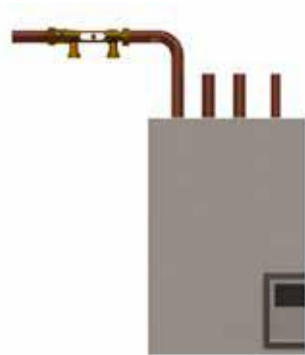

# Smart Plumb Compact Installation Maintenance

## General

Servicing should only be carried out by competent installers and any spare parts must be purchased from Joule



Never bypass any safety devices or operate the unit without being fully operational.

## Draining

Switch the electrical power off (important to avoid damage to element). Isolate the power supply to the unit. Turn off the cold water supply valve. Open hot water tap. Open the drain valve. The unit will drain.



Water drained off may be very hot!

## Annual Maintenance

The water heaters require annual servicing in order to ensure safe working and optimum performance. It is essential that the following checks are performed by a competent installer on an annual basis. This is commonly done at the same time as the annual boiler service.

- Twist the cap for the expansion relief valve on the inlet control set and allow water to flow for 5 seconds. Release and make sure it resets correctly.
- Repeat with the pressure/temperature relief valve. In both cases check that the discharge pipework is carrying the water away adequately. If not, check for blockages etc. and clear.
- Check that any immersion heaters fitted are working correctly and that they are controlling the water at a temperature between 55°C and 65°C.
- Check the pressure in the expansion vessel is charged to 3 bar. Turn off the water supply to the unit and open a hot tap first. The air valve on expansion vessel is a Schrader (car tyre) type.
- Air or CO<sub>2</sub> may be used to charge the expansion vessel. Unscrew the head on the inlet control set and clean the mesh filter within.

The Service Log Book supplied with this unit should be updated at each service.



Your guarantee may be void if you cannot produce proof of annual servicing immersion heater replacement

# Smart Plumb Compact Installation

## Field Setting Parameters

### How to enter Service Mode

Using two hands, **push and hold** the up and down arrows for **10 seconds**



Password will appear, the password is **0202**

Use arrows to enter password

### Accessing And Adjusting The Field Settings

Use  to highlight field setting value



Push  arrow to enter

Use   arrows to select sub menu required.

Example for weather comp and heating flow high light 20 – water law

Push  arrow to enter sub menu

You will see the individual settings within this menu.

Use  and  to set FSV

Example 2011 Low set is 15, High set is 2.0

Once set push **OK** and Saving FSV will be displayed.

You will then **return** to the heat sub menu.

You can then use  and  arrows to highlight other heat settings push right arrow to enter.

To go back to FSV menu use the back key and you can then move to other sub menus such as DHW.

To **exit FSV mode** push  until you return to the front Screen.



# Smart Plumb Compact Installation

## Field Setting Parameters

### Field Setting Parameters For Smart Plumb Cylinder Units - 3 Zone



If you set a field setting and go back to check it, it will not have changed. The field setting does not get written to the PCB unless you push SET after changing it.

Field Setting	Set To	Description
20-11	-2	Low ambient temp setting for optimisation.
20-12	+15	High ambient temp setting for optimisation.
20-21	40°C	Maximum flow temperature for heating circuit 1 at set value of 20-11. This should be set to the designed flow temperature used to calculate the size of the underfloor heating system. If the underfloor has been designed and supplied by Joule set the temperature to 40°C.
20-22	35°C	Minimum flow temperature for heating circuit 1 at set value of 20-12. This should be set to 35°C.
20-31	48°C	Maximum flow temperature for heating circuit 2 at set value of 20-11. This should be set to the designed flow temperature used to calculate the size of the radiators. If the radiators have been sized by Joule set the temperature to 48°C.
20-32	35°C	Minimum flow temperature for heating circuit 2 at set value of 20-12. This should be set to 35°C.
20-91	1	External Run input for Zone 1 ( Room stat ) (Not Use, Recommended-Use Use(Signal ON/OFF) or WL Interlink OFF(Water Pump1) Use(Signal ON/OFF) or WL Interlink OFF(Water Pump2) Use(Signal ON/OFF) or WL Interlink OFF(Water Pump3)
20-92	1	External Run input for Zone 1 ( Room stat ) (Not Use, Recommended-Use Use(Signal ON/OFF) or WL Interlink OFF(Water Pump1) Use(Signal ON/OFF) or WL Interlink OFF(Water Pump2) Use(Signal ON/OFF) or WL Interlink OFF(Water Pump3)
30-11	1	Tells the unit it has a cylinder connected.
30-25	200L cyl.=50min 300L cyl.=90min	Maximum cylinder heating time from heat pump before turning back to heating zones.
30-32	200L cyl.=50min 300L cyl.=90min	Maximum cylinder heating time from heat pump before turning on immersion to support it.
30-42	T (Tuesday)	Legionella function activates on this day.
30-43	3am	Legionella function activates on this hour.
30-44	60°C	Legionella function raises water temp to this.
30-51	-	Enables the timer for DHW Boost mode.
30-52	60	Should automatically be set to 60 minutes, this is the max time in boost mode before the unit reverts back to normal operation.
30-83	3	Booster Heater Capacity

Once the parameters have been set, push the Escape key once and the controller should revert back to just showing the time.

# Controller Symbols

## Button Functions

### Controller

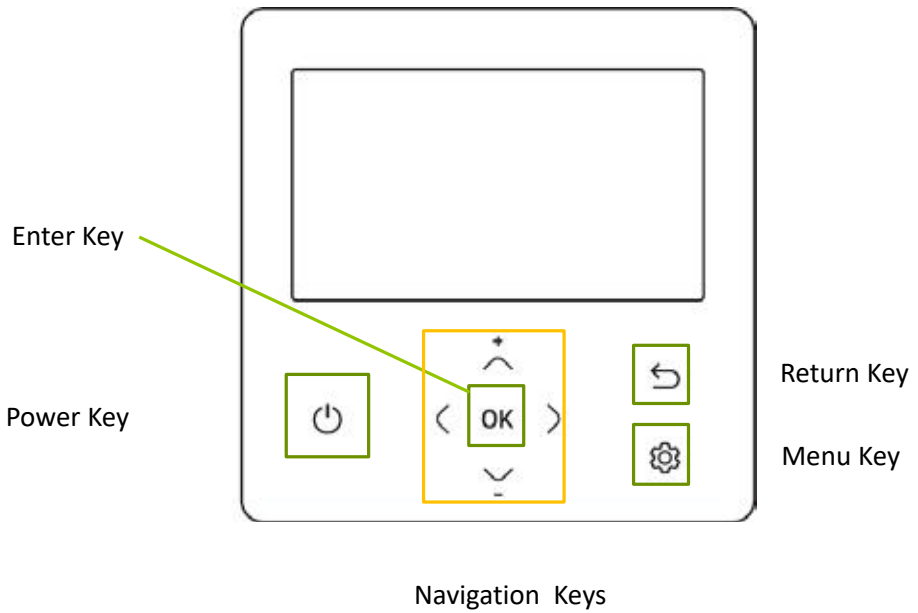



# Fault Codes

Error Code	Contents	Measure	Product op. in error condition	Error Type
			Outdoor unit / Comp. / Ind. unit	
101	Indoor unit communication error	Check the communication cable of indoor unit. Check the DC output voltage at the communication terminal.	Operation off	Communication error
102	Indoor unit/outdoor unit communication time-out error: errors in more than 6 packets	Check the outdoor communication cable connection. Check DC output voltage and the communication terminal.	Operation off	Communication error
121	Indoor temperature sensor (open/short error)	Check indoor unit room temperature sensor. Check indoor unit PCB connector CN41 (White)	Operation off	Indoor sensor error
122	Indoor unit Eva in sensor (Open/Short)	Check indoor unit pipe sensor. Check indoor PCB connector CN41 (White)	Operation off	Indoor sensor error
128	Indoor unit Eva in sensor disconnection	Check the disconnection of indoor unit pipe sensor.	Operation off	Indoor sensor error
153	Indoor floating switch secondary detection	Check indoor unit float sensor. Check indoor PCB connector CN5 (black)	Operation off	Self diagnostic error
202	Indoor/outdoor communication error (1 min)	Check the communication connection between indoor and outdoor units. Check the power line and communication cable connection status.	Operation off	Communication error
203	Communication error between indoor/outdoor INVIMAIN <-> MICOM (1 min)	Check MAIN MICOM Check INVERTER MICOM	Operation off	Communication error
221	Outdoor temperature sensor error	Check sensor connection status Check sensor location Check sensor resistance	Operation off	Outdoor sensor error
237	COND temperature sensor error	Check sensor connection status Check sensor location Check sensor resistance	Operation off	Outdoor sensor error
251	[Inverter] Emission temperature sensor error	Check sensor connection status Check sensor location Check sensor resistance	Operation off	Outdoor sensor error

Error Code	Contents	Measure	Product op. in error condition	Error Type
			Outdoor unit / Comp. / Ind. unit	
440	Heating operation blocked	Check the operation setting state Check temperature sensor	Operation off	Self diagnostic error
458	Outdoor fan 1 error	Check input power connection status Check the connection status between the motor and outdoor unit of PCB Check indoor/outdoor fuse	Operation off	Self diagnostic error
461	[Inverter] Compressor startup error	Check the compressor connection status Check the resistance between different phases of the compressor	Operation off	Outdoor unit protection control error
462	[Inverter] Total current error / PFC over current error	Check the input power Check the coolant charging status Check the normal operation of outdoor fan	Operation off	Outdoor unit protection control error
464	[Inverter] IPM over current error	Check coolant charging Check the compressor connection status and normal operation Check the obstacles around the indoor and outdoor units Check whether the outdoor unit service valve is open Check whether the indoor/outdoor installation pipe/wiring are correct	Operation off	Outdoor unit protection control error
465	Compressor V limit error	Check the compressor connection status Check the resistance between different phases of the compressor	Operation off	Outdoor unit protection control error
466	DC LINK over/low voltage	Check input power Check AC power connection	Restart in 3 minutes	Outdoor unit protection control error
467	[Inverter] Compressor rotation error	Check the compressor connection status Check the resistance between different phases of the compressor	Operation off	Outdoor unit protection control error
468	[Inverter] Current sensor error	Check EEPROM DATA Check the normal operation of PCB	Operation off	Outdoor unit protection control error
469	[Inverter] DC LINK voltage sensor error	Check the input power connection Check the status of RY21 and R200 in the INVERTER PCB	Operation off	Outdoor unit protection control error
471	[Inverter] OTP error	Check EEPROM DATA Check the normal operation of PCB	Operation off	Outdoor unit protection control error

# Fault Codes

Error Code	Contents	Measure	Product op. in error condition	Error Type
			Outdoor unit / Comp. / Ind. unit	
475	Outdoor fan 2 error	Check the input power connection status Check the connection status of the motor and the outdoor unit PCB Check the indoor/outdoor unit fuse	Operation off	Self diagnostic error
554	Gas leak error	Check the coolant charging status Check the indoor EVA sensor Check if the outdoor unit service valve is open Check that the indoor/outdoor installation pipe/wiring are correct	Operation off	Self diagnostic error
556	Capacities not matched	Check the option code of the indoor unit	Operation off	Outdoor unit protection control error
601	Communication error between the indoor unit and wired remote controller	Check the connection wire between the indoor unit and the wired remote controller	Operation off	Wired remote controller error
602	Communication error between the Master and Slave wired remote controllers	Check the option switch for defining the master and slave (only one master and one slave can exist)	Normal operation	Wired remote controller error
606	COM1/COM2 cross installation error	Check that wired remote controller is connected to the COM2 terminal of the indoor unit	Normal operation	Wired remote controller error
607	Communication error between the Master and Slave wired remote controllers.	Check the option switch for defining the master and slave (only one master and one slave can exist)	Normal operation	Wired remote controller error

# Troubleshooting

Error Code	Meaning	Troubleshooting
<b>E177</b>	Emergency stop	Indoor unit (\$POUSPM kit) orders emergency stop. Check the indoor unit (\$POUSPM kit)
<b>E201</b>	Control kit quantity is mismatched.	Control kit quantity must be matched with outdoor unit 1 by 1. Check the \$POUSPM kit quantity. It must be 1EA.
<b>E403</b>	Detection of outdoor freezing when compressor stops.	Outdoor unit (condenser) froze. Check condenser.
<b>E404</b>	Protection of outdoor overload when compressor stops.	Compressor is overloaded. Please check same as E461 and check compressor when it starts.
<b>E416</b>	Discharge temperature of a compressor in an outdoor unit is overheated.	Discharge temperature is overheated.
<b>E440</b>	Heating operation is not available since the outdoor air temperature is over 35 degrees.	Check the outdoor temperature.
<b>E441</b>	Cooling operation is not available since the outdoor air temperature is lower than -15 degrees.	Check the outdoor temperature.
<b>E465</b>	Compressor overload error	Compressor is overloaded. Please check same as E461 and check compressor when it starts.
<b>E468</b>	Current sensor error	Exchange INVERTER PBA.
<b>E471</b>	Outdoor EEPROM error	EEPROM date is wrong. Exchange EEPROM or MAIN PBA. (This error doesn't occur in EMF 150-AM)
<b>E474</b>	IPM (IGBT Module) or PFCM temperature sensor error	Exchange INVERTER PBA.
<b>E484</b>	PFC overload error	Check reactor located in control plate. If reactor is normal, exchange INVERTER PEA.
<b>E500</b>	IPM is over heated	Check INVERTER PBA's temperature. Power off and cool down INVERTER PBA, and then restart the outdoor unit.
<b>E556</b>	Capacity mismatching between indoor and outdoor	EEPROM data is wrong. Exchange EEPROM or MAIN PBA
<b>E557</b>	Option code miss matching among the indoors (only for DPM)	EEPROM data is wrong. (This error doesn't occur in EMF 150-AM)
<b>E911</b>	Emergency stop	Ensure flow switch is fitted onto pipework and connected to Samsung PCB. Ensure flow rate is above 16 litres per minute. Ensure all air is removed from system. Check circulation pumps speed setting. Check zone valves are not sticking closed. Check direction of flow switch on pipework. Check direction of pump on pipework. Check direction of Flow Meter on pipework.
<b>E912</b>	Emergency stop	Check circulation pumps are not operating. check flow switch is installed on horizontal pipework. Ensure 150mm of horizontal pipework each side of flow switch.

# Control Kit EHS Monoblock Wiring

Terminal No.	Function	Description
<b>N</b>	230V AC Neutral Output	Neutral Output to DHW Immersion
<b>L</b>	230V AC Live Output	Live Output to DHW Immersion
<b>B1</b>	230V AC Neutral Output	Neutral Output to Backup Immersion Cable
<b>B2</b>	230V AC Live Output	Live Output to Backup immersion Cable
<b>B4</b>	230V AC Live Output	Live Output to Backup Boiler (1.5mm <sup>2</sup> cable)
<b>B5</b>	230V AC Neutral Output	Neutral Output to Circulation Pump (1.5mm <sup>2</sup> cable)
<b>B7</b>	230V AC Neutral Output	Neutral Output to DHW Zone Valve (1.5mm <sup>2</sup> cable)
<b>B8</b>	230V AC Live Output	Live Output to Circulation Pump (1.5mm <sup>2</sup> cable)
<b>B10</b>	230V AC Live Output	Live Output to Heating Zone Valve 1 (Brown Cable) - Where no Buffer installed
<b>B14</b>	230V AC Live Output	Live Output to Heating Zone Valve 2 (Brown Cable) - Where no Buffer installed
<b>B15</b>	230V AC Neutral Output	Neutral output to Heating Zone Valve (Blue Cable)
<b>B17</b>	230V AC Live Output	Live Output to DHW Zone Valve (Brown Cable)
<b>B18</b>	230V AC Live Input	Live Output to Buffer Heating Zone Valve (Brown Cable)
<b>B19</b>	230V AC Neutral Output	Neutral Output to Time Clock (1.5mm <sup>2</sup> cable)
<b>B20</b>	230V AC Live Output	Permanent Live to Time Clock (1.5mm <sup>2</sup> cable)
<b>B22</b>	230V AC Live Input	Switch Live back from Time Clock for Heating Zone 1
<b>B24</b>	230V AC Live Input	Switch Live back from Time Clock for Heating Zone 2
<b>V1</b>	12V Input	Input from Samsung Commissioning Controller
<b>V2</b>	12V Input	Input from Samsung Commissioning Controller
<b>F3</b>	12V Input	Wifi Module Connection
<b>F4</b>	12V Input	Wifi Module Connection
<b>V1</b>	12V Input	Input from Samsung Commissioning Controller
<b>V2</b>	12V Input	Input from Samsung Commissioning Controller
<b>F3</b>	12V Input	Wifi Module Connection
<b>F4</b>	12V Input	Wifi Module Connection
<b>F1</b>	12V Comms	Communication between External Heat Pump and internal PCB (CAT 5 Shielded)
<b>F2</b>	12V Comms	Communication between External Heat Pump and internal PCB (CAT 5 Shielded)
<b>Earths</b>		Connected to Earth Bar



**Figure 1.1**  
**Air Source Heat Pump & Unplumbed Smartplumb (1 Heating & 1 DHW)**

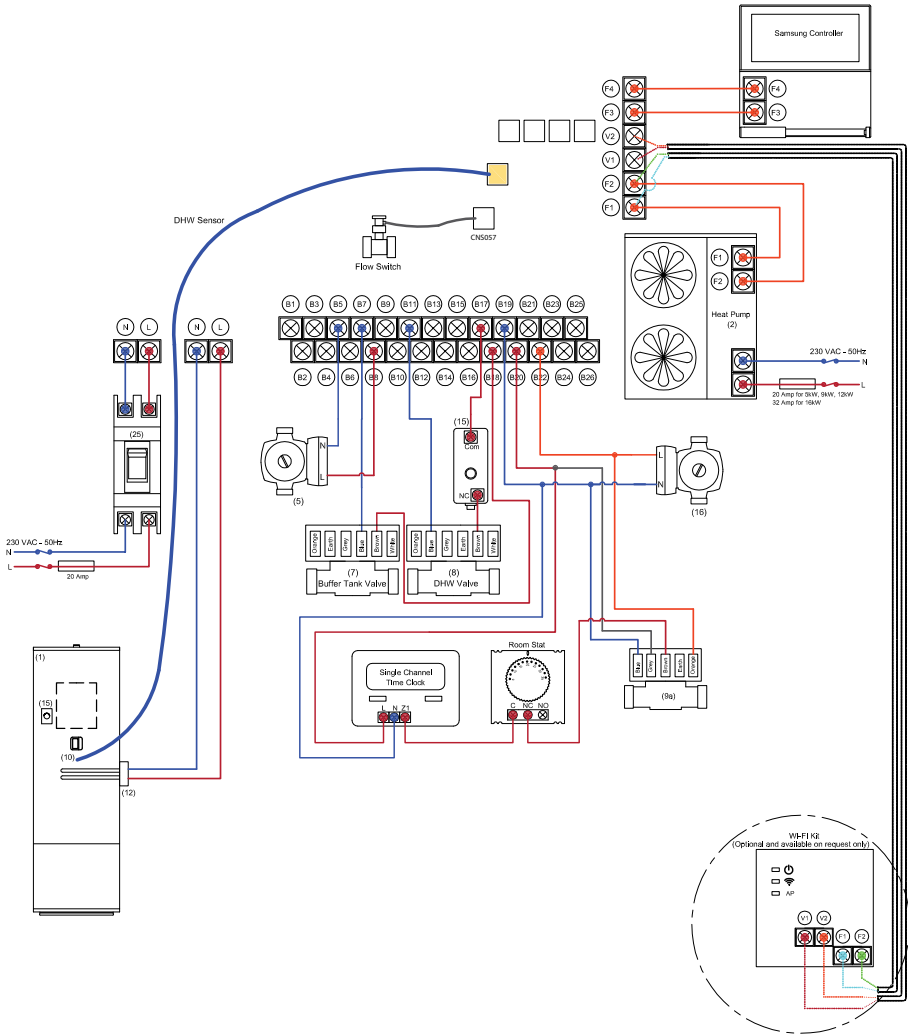

**Figure 1.2**  
**Air Source Heat Pump & Unplumbed Smartplumb (2 Heating & 1 DHW)**

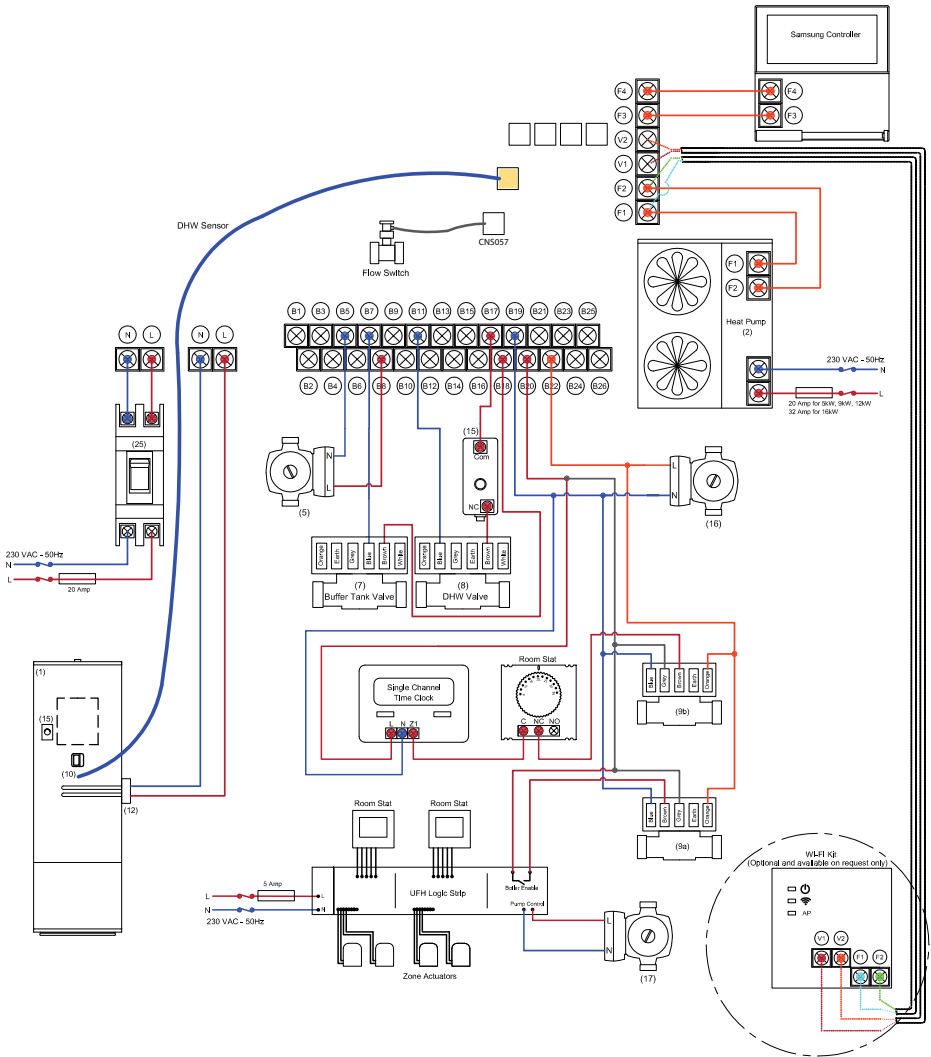

**Figure 1.3**  
**Air Source Heat Pump & Unplumbed High Gain Indirect (1 Heating & 1 DHW)**

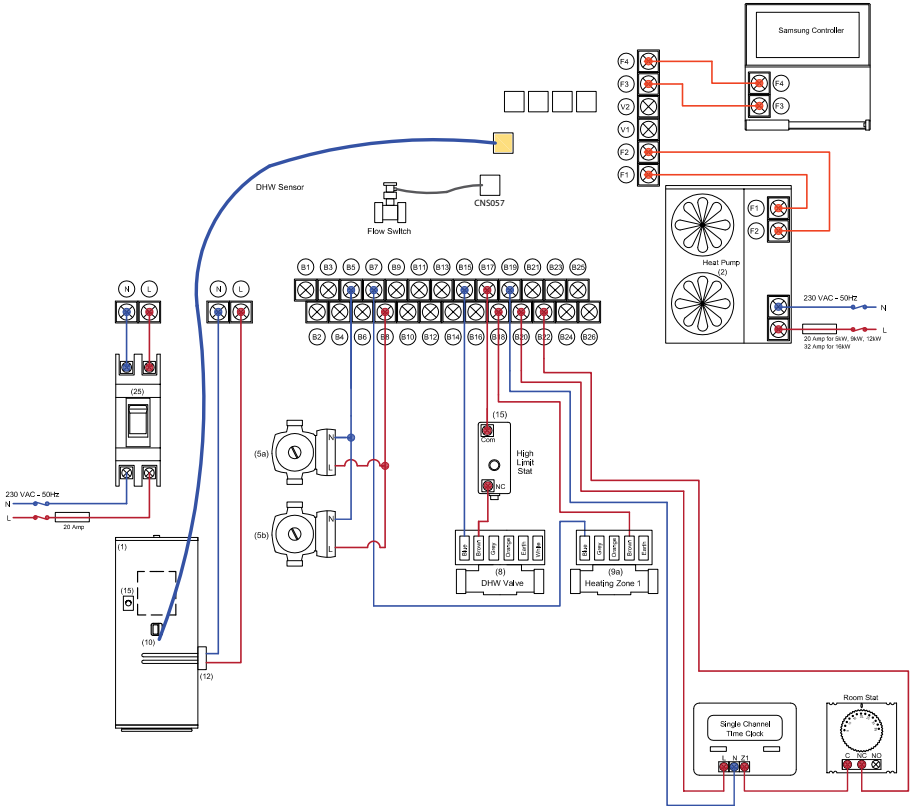

**Figure 1.4**  
**Air Source Heat Pump & Unplumbed High Gain Indirect (2 Heating & 1 DHW)**

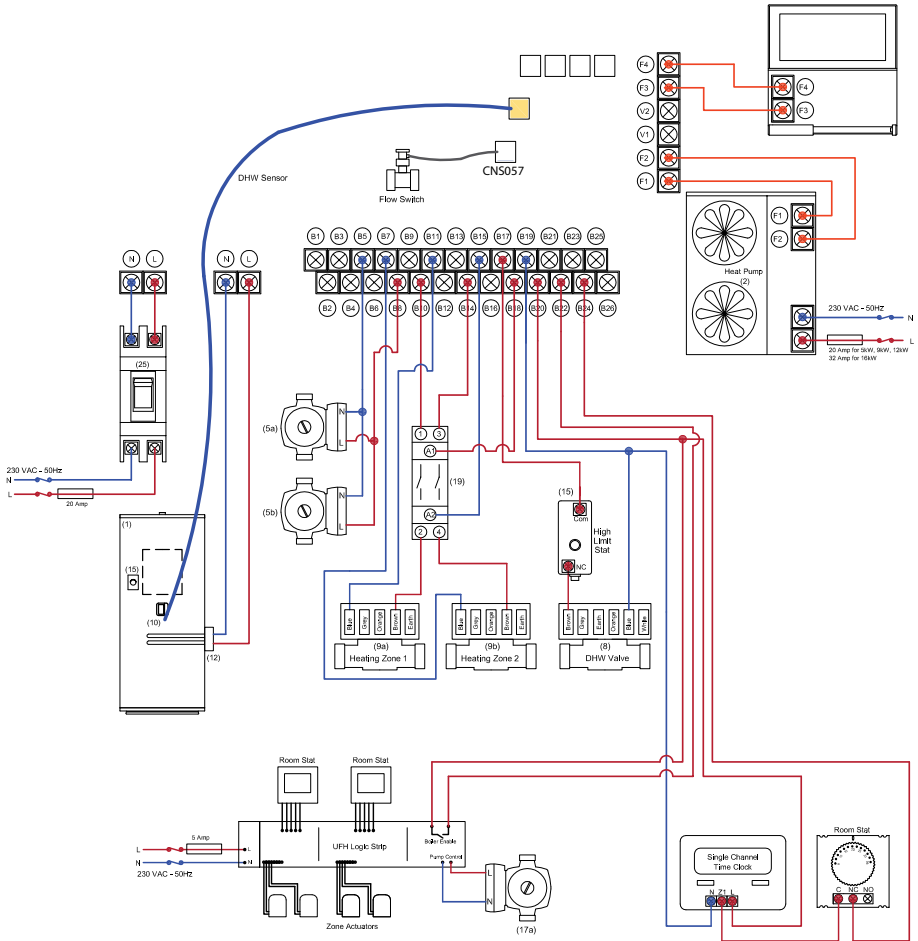

**Figure 1.5**  
**Air Source Heat Pump & Pre Plumbed Smartplumb (1 Heating & 1 Cooling)**

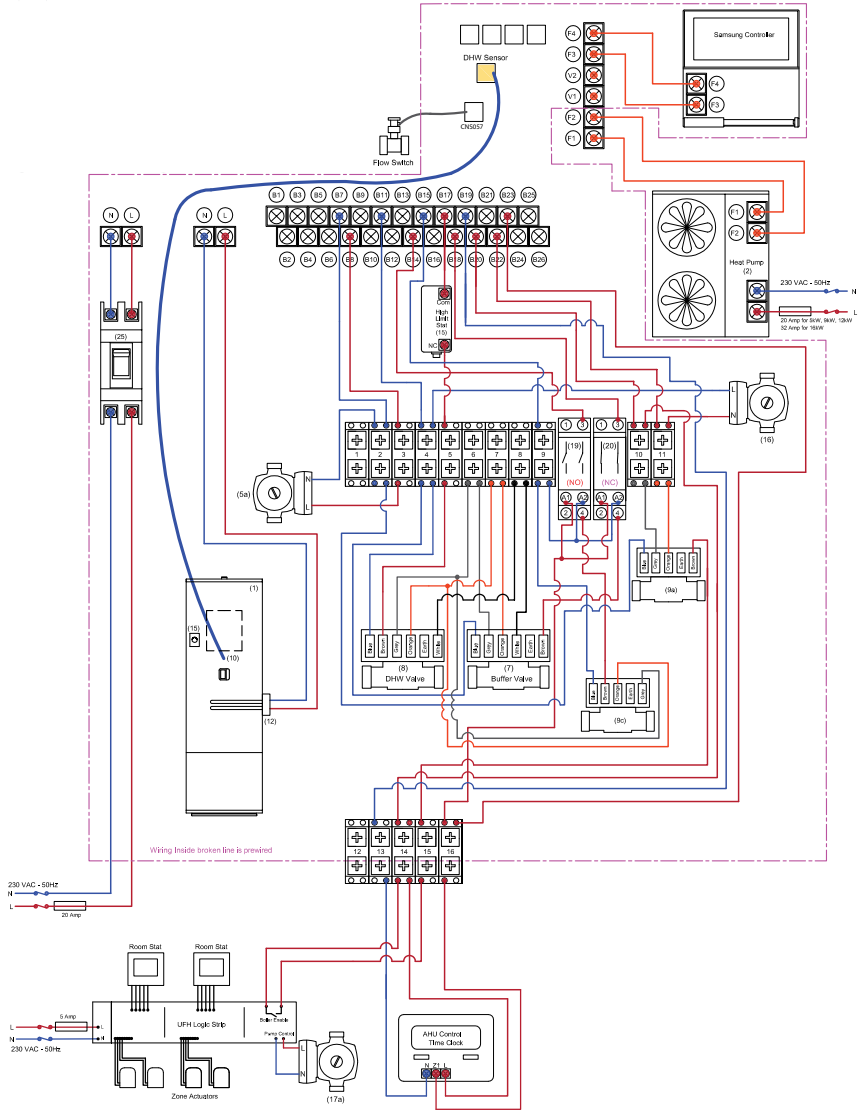

# Service Record

It is recommended that your hot water system is serviced regularly and that the appropriate Service Record's completed.

## Service Provider

Before completing the appropriate Service Record below, please ensure you have carried out the service as described in the manufacturer's instructions.

**Service 1** Date .....

Engineer Name .....

Company Name .....

Telephone No .....

Comments .....

.....

.....

Signature .....

**Service 1** Date .....

Engineer Name .....

Company Name .....

Telephone No .....

Comments .....

.....

.....

Signature .....

**Service 1** Date .....

Engineer Name .....

Company Name .....

Telephone No .....

Comments .....

.....

.....

Signature .....

**Service 1** Date .....

Engineer Name .....

Company Name .....

Telephone No .....

Comments .....

.....

.....

Signature .....

**Service 1** Date .....

Engineer Name .....

Company Name .....

Telephone No .....

Comments .....

.....

.....

Signature .....

**Service 1** Date .....

Engineer Name .....

Company Name .....

Telephone No .....

Comments .....

.....

.....

Signature .....

**Service 1** Date .....

Engineer Name .....

Company Name .....

Telephone No .....

Comments .....

.....

.....

Signature .....

**Service 1** Date .....

Engineer Name .....

Company Name .....

Telephone No .....

Comments .....

.....

.....

Signature .....

**Service 1** Date .....

Engineer Name .....

Company Name .....

Telephone No .....

Comments .....

.....

.....

Signature .....

**Service 1** Date .....

Engineer Name .....

Company Name .....

Telephone No .....

Comments .....

.....

.....

Signature .....



#### **JOULE IE**

mail Kylesmore Park West, Ballyfermot, Dublin 10  
tel +353 (1) 623 7080  
fax +353 (1) 626 9337  
eml info@joule.ie  
web www.joule.ie

#### **JOULE PL**

mail 23-200 Kraśnik, ul. Towarowa 34.  
tel +48 (0) 128811171  
fax +48 (0) 814709046  
eml biuro@joule-pl.pl  
web www.joule-pl.pl

#### **JOULE UK**

mail Unit 17C&D Power Road, Plantation Bus. Pk.  
Bromborough, Wirral, CH62 3RN  
tel +44 (0) 1513 551 094  
fax +44 (0) 1513 568 336  
eml info@jouleuk.co.uk  
web www.jouleuk.co.uk