

## Wilo-Para



**de** Einbau- und Betriebsanleitung  
**en** Installation and operating instructions



**fr** Notice de montage et de mise en service

Fig. 1:

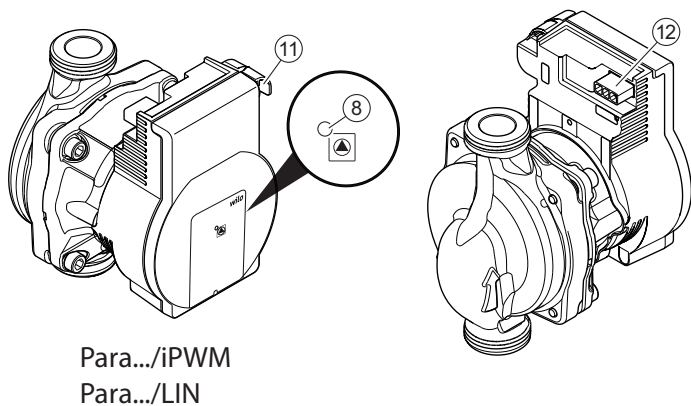
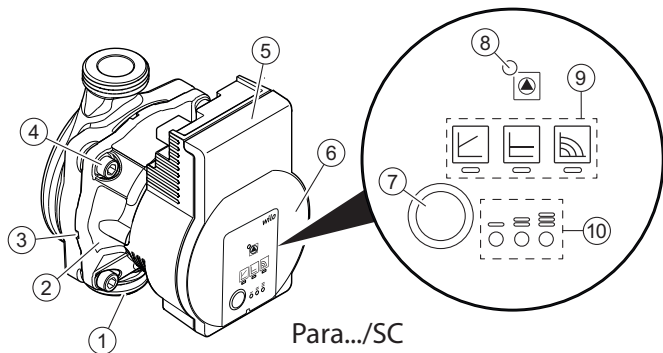

Fig. 2:

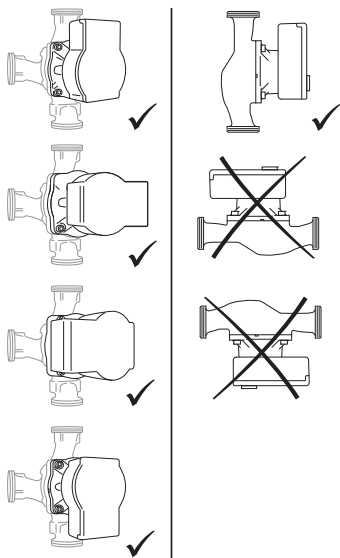

Fig. 3:

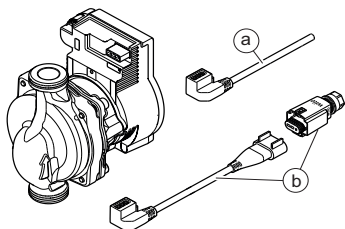
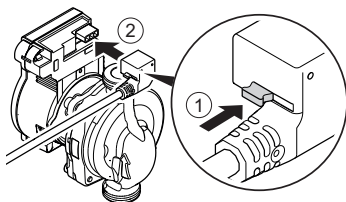

Fig. 4:



## 1 General

### ***About these instructions***

These installation and operating instructions are an integral part of the product. Read these instructions before commencing work and keep them in an accessible place at all times.

Strict adherence to these instructions is a requirement for intended use and correctly operating the product. All specifications and markings on the product must be observed.

The language of the original operating instructions is German. All other languages of these instructions are translations of the original operating instructions.

## 2 Safety

This section contains basic information which must be adhered to during installation, operation and maintenance. Additionally, the instructions and safety instructions in the other sections must be followed.

Failure to follow the installation and operating instructions will result in the risk of injury to persons and damage to the environment and the product. This will result in the loss of any claims for damages.

Failure to follow the instructions will, for example, result in the following risks:

- Injury to persons from electrical, mechanical and bacteriological factors as well as electromagnetic fields
- Environmental damage from leakage of hazardous substances
- Property damage
- Failure of important functions of the product

### ***Identification of safety instructions***

These installation and operating instructions set out safety instructions for preventing personal injury and damage to property, which are displayed in different ways:

- Safety instructions relating to personal injury start with a signal word and are **preceded by a corresponding symbol**.

- Safety instructions relating to property damage start with a signal word and are displayed **without** a symbol.

**Signal words** **DANGER!**

Failure to observe safety instructions will result in serious injury or death!

**WARNING!**

Failure to follow instructions can lead to (serious) injury!

**CAUTION!**

Failure to follow instructions can lead to property damage and possible total loss.

**NOTICE**

Useful information on handling the product

**Symbols** These instructions use the following symbols:



Danger due to electrical voltage



General danger symbol



Warning of hot surfaces/fluids



Warning of magnetic fields



Notices

**Personnel qualifications** Personnel must:

- Be instructed about locally applicable regulations governing accident prevention.
- Have read and understood the installation and operating instructions.

Personnel must have the following qualifications.

- Electrical work must be carried out by an authorised electrician (in accordance with EN 50110-1).

- Installation/dismantling must be carried out by a qualified technician who is trained in the use of the necessary tools and fixation materials.
- The product must be operated by persons who are instructed on how the complete system functions.

#### **Definition of “qualified electrician”**

A qualified electrician is a person with appropriate technical training, knowledge and experience who can identify and prevent electrical hazards.

#### ***Electrical work***

- Electrical work must be performed by a qualified electrician.
- Nationally applicable guidelines, standards and regulations as well as specifications issued by the local energy supply companies for connection to the local power supply system must be observed.
- Before commencing work, disconnect the product from the mains and safeguard it from being switched on again.
- The connection must be protected by means of a residual-current device (RCD).
- The product must be earthed.
- Have defective cables replaced immediately by a qualified electrician.
- Never open the control module and never remove operating elements.

#### ***Operator responsibilities***

- Have all work carried out by qualified personnel only.
- Ensure on-site guard against hot components and electrical hazards.
- Have defective gaskets and connection pipes replaced.

This device can be used by children from 8 years of age as well as by people with reduced physical, sensory or mental capacities or lack of experience and knowledge if they are supervised or instructed in the safe use of the device and they understand the dangers that can occur. Children are not allowed to play with the device. Cleaning and user maintenance must not be carried out by children without supervision.

### 3 Product description and function

- Overview** Wilo-Para (Fig. 1)
- 1 Pump housing with screwed connections
  - 2 Glandless motor
  - 3 Condensate drain openings (4x around circumference)
  - 4 Housing screws
  - 5 Control module
  - 6 Rating plate
  - 7 Operating button for pump adjustment
  - 8 Run signal/fault signal LED
  - 9 Display of selected control mode
  - 10 Display of selected characteristic curve (I, II, III)
  - 11 PWM or LIN signal cable connection
  - 12 Mains connection: 3-pin plug connection

**Function** High-efficiency circulator for hot-water heating systems with integrated differential pressure control. Control mode and delivery head (differential pressure) are adjustable. The differential pressure is controlled via the pump speed.

#### Type key

Example: Wilo-Para 15-130/7-50/SC-12/I

Para	High-efficiency circulator
15	15 = screwed connection DN 15 (Rp ½) DN 25 (Rp 1), DN 30 (Rp 1¼)
130	Port-to-port length: 130 mm or 180 mm
7	7 = maximum delivery head in m at Q = 0 m³/h
50	50 = max. power consumption in watts
SC	SC = Self-Control iPWM1 = external control via iPWM1 signal iPWM2 = external control via iPWM2 signal
12	Position of the control module at 12 o'clock
I	Individual packaging

## Technical data

Connection voltage	1 ~ 230 V +10 %/-15 %, 50/60 Hz
Protection class	IPX4D
Energy efficiency index EEI	See rating plate (6)
Fluid temperatures at max. ambient temperature +40 °C	-20 °C to +95 °C (Heating/GT) -10 °C to +110 °C (ST)
Ambient temperature +25 °C	0 °C to +70 °C
Max. operating pressure	10 bar (1000 kPa)
Min. inlet pressure at +95 °C/+110 °C	0.5 bar / 1.0 bar (50 kPa / 100 kPa)

### Indicator lights (LEDs)



- Signal display
  - LED is lit up in green in normal operation
  - LED lights up/flashes in case of a fault (see chapter 10.1)



- Display of selected control mode  $\Delta p$ -v,  $\Delta p$ -c and constant speed



- Display of selected pump curve (I, II, III) within the control mode



- LED indicator combinations during the pump venting function, manual restart and key lock





## Operating button

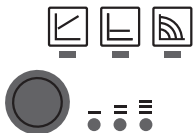

Press

- Select control mode
  - Select pump curve (I, II, III) within the control mode
- Press and hold

- Activate the pump venting function (press for 3 seconds)
- Activate manual restart (press for 5 seconds)
- Lock/unlock button (press for 8 seconds)

### 3.1 Control modes and functions

#### **Variable differential pressure** $\Delta p-v$ (I, II, III)

Recommended for two-pipe heating systems with radiators to reduce the flow noise at thermostatic valves.

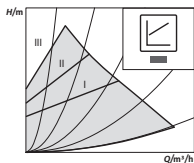

The pump reduces the delivery head to half in the case of decreasing volume flow in the pipe network.

Electrical energy saving by adjusting the delivery head to the volume flow requirement and lower flow rates.

There are three pre-defined pump curves (I, II, III) to choose from.

#### **Constant differential pressure** $\Delta p-c$ (I, II, III)

Recommended for underfloor heating for large-sized pipes or all applications without a variable pipe network curve (e.g. storage charge pumps), as well as single-pipe heating systems with radiators.

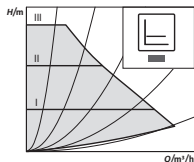

The control keeps the set delivery head constant irrespective of the pumped volume flow.

There are three pre-defined pump curves (I, II, III) to choose from.

## Constant speed (I, II, III)

Recommended for systems with fixed system resistance requiring a constant volume flow.

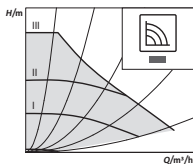

The pump runs in three prescribed fixed speed stages (I, II, III).



### NOTICE

Factory setting:  
Constant speed, pump curve III

## External control via iPWM signal

The required setpoint/actual value comparison for control is performed by an external controller.

A PWM signal (pulse-width modulation) is fed as a correcting variable to the pump.

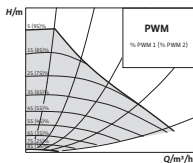

The PWM signal generator gives the pump a periodic sequence of impulses (the duty cycle) in accordance with DIN IEC 60469-1.

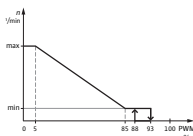

### iPWM 1 mode (heating application):

In iPWM 1 mode, the pump speed is controlled according to the PWM input signal.

Behaviour in the event of a cable break:

If the signal cable is disconnected from the pump, e.g. due to a cable break, the pump accelerates to maximum speed.

### PWM signal input [%]

- < 5: Pump runs at maximum speed
- 5–85: The speed of the pump decreases linearly from  $n_{\max}$  to  $n_{\min}$
- 85–93: Pump runs at minimum speed (operation)
- 85–88: Pump runs at minimum speed (starting)
- 93–100: Pump stops (standby)

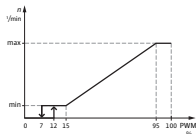

### iPWM 2 mode:

In iPWM 2 mode, the pump speed is controlled according to the PWM input signal.

Behaviour in the event of a cable break:

If the signal cable is disconnected from the pump, e.g. due to a cable break, the pump stops.

### PWM signal input [%]

0–7: Pump stops (standby)

7–15: Pump runs at minimum speed (operation)

12–15: Pump runs at minimum speed (starting)

15–95: The speed of the pump increases linearly from  $n_{\min}$  to  $n_{\max}$

> 95: Pump runs at maximum speed

### Venting

The **pump venting function** is activated by pressing and holding the operating button (for 3 seconds) and automatically vents the pump.

However, this function does not vent the heating system.

### Manual restart

A **manual restart** is initiated by pressing and holding the operating button (for 5 seconds) and unblocks the pump as required (e.g. after a long idle time in the summer).

### Lock/unlock the button

The **key lock** is activated by pressing and holding the operating button (for 8 seconds) and locks the pump's current settings. It protects against undesired or unauthorised adjustment of the pump.

### Activating factory setting

The **factory setting** is activated by pressing and holding the operating button whilst switching off the pump. When the pump is switched on again, the pump runs using the factory settings (delivery condition).

## 4 Intended use

High-efficiency circulators in the Wilo-Para series are exclusively intended for circulating fluids in hot-water heating systems and similar systems with constantly changing volume flows.

Permitted fluids:

- Heating water according to VDI 2035 (CH: SWKI BT 102-01).
- Water-glycol mixtures\* with a maximum of 50% glycol.

\* Glycol has a higher viscosity than water. If admixtures of glycol are used, the pumping data of the pump must be corrected to match the mixing ratio.



### NOTICE

Only introduce ready-to-use mixtures to the system. The pump must not be used to mix fluid in the system.

---

Intended use includes observing these instructions and the specifications and markings on the pump.

**Misuse** Any use beyond the intended use is considered misuse and will void any warranty claims.



### WARNING!

**Danger of injury or material damage from improper use!**

- Never use non-specified fluids.
- Never allow unauthorised persons to carry out work.
- Never operate the pump beyond the specified limits of use.
- Never carry out unauthorised conversions.
- Use authorised accessories only.
- Never operate with phase angle control.

## 5 Transportation and storage

- Scope of delivery**
- High-efficiency circulator
  - Installation and operating instructions
- Accessories** Accessories must be ordered separately. For a detailed list and description, consult the catalogue.  
The following accessories are available:
- Mains connection cable
  - iPWM/LIN signal cable
  - Thermal insulation shell
  - Cooling shell
- Transport inspection** Immediately check for transportation damage and completeness upon delivery, and lodge any complaints immediately.
- Transport and storage conditions** Protect against moisture, frost and mechanical loads.  
Permissible temperature range: -40 °C to +85 °C (for max. 3 months)

## 6 Installation and electrical connection

### 6.1 Installation

May only be installed by qualified technicians.



#### **WARNING!**

#### **Risk of burns from hot surfaces!**

Pump housing (1) and glandless motor (2) may become hot and cause burns if touched.

- During operation, only touch the control module (5).
- Allow the pump to cool down before commencing any work.

**WARNING!****Risk of scalding from hot fluids!**

Hot fluids can cause scalding. Before installing or removing the pump, or loosening the housing screws (4), note the following:

- Allow the heating system to cool down completely.
- Close shut-off devices or drain the heating system.

**Preparation****Installation within a building:**

- Install the pump in a dry, well-ventilated, frost-free room.

**Installation outside a building (outdoor installation):**

- Install the pump in a chamber with cover or in a cabinet/housing as weather protection.
- Avoid exposure of the pump to direct sunlight.
- Protect the pump against rain.
- Keep the motor and electronics continually ventilated to avoid overheating.
- The permitted fluid temperatures and ambient temperatures should not be exceeded or undershot.
- Choose an installation point that is as easily accessible as possible.
- Observe the pump's permitted installation position (Fig. 2).

**CAUTION!**

An incorrect installation position may damage the pump.

- Select the installation point in line with the permissible installation position (Fig. 2).
  - The motor must always be installed horizontally.
  - The electrical connection must never face upwards.
- 
- Install shut-off devices upstream and downstream of the pump to facilitate pump replacement.

**CAUTION!**

Leaking water may damage the control module.

- Align the upper shut-off device so that leaking water cannot drip onto the control module (5).
- If the control module is sprayed with liquid, the surface must be dried off.

- Align the upper shut-off device laterally.
- When installing in the feed of open systems, the safety supply must branch off upstream of the pump (EN 12828).
- Complete all welding and brazing work.
- Flush the pipe system.
- Do not use the pump to flush the pipe system.

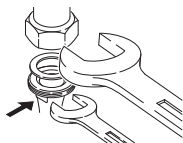
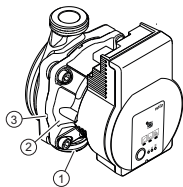
**Installing the pump**

Observe the following points when installing the pump:

- Note the direction arrow on the pump housing (1).
- Install glandless motor (2) horizontally, without mechanical tension.
- Place gaskets in the screwed connections.
- Screw on threaded pipe unions.
- Use an open-end wrench to secure the pump against twisting and screw tightly to piping.
- Re-mount the thermal insulation shell if required.

**CAUTION!**

Insufficient heat dissipation and condensation water may damage the control module and the glandless motor.

- Do not thermally insulate the glandless motor (2).
- Ensure all condensate drain openings (3) are kept free.

**WARNING!****Risk of fatal injury from magnetic field!**

Risk of fatal injury for people with medical implants due to permanent magnets installed in the pump.

- The motor must never be removed.

## 6.2 Electrical connection

The electrical connection may only be carried out by a qualified electrician.

**DANGER!****Risk of fatal injury from electrical voltage!**

Immediate risk of fatal injury if live components are touched.

- Before commencing work, switch off the power supply and secure it from being switched on again.
- Never open the control module (5) and never remove operating elements.

---

**CAUTION!**

Pulsed mains voltage can cause damage to electronic components.

- Never operate the pump with phase angle control.
  - For applications where it is not clear whether the pump is operated with pulsed voltage, get the control/system manufacturer to confirm that the pump is operated with sinusoidal AC voltage.
  - Switching the pump on/off via triacs/solid-state relays must be examined on a case-by-case basis.
-



- Preparation**
- The current type and voltage must correspond to the specifications on the rating plate (6).
  - Maximum back-up fuse: 10 A, slow-blow.
  - Only operate the pump with sinusoidal AC voltage.
  - Note the switching frequency:
    - On/off switching operations via mains voltage  $\leq 100/24$  h.
    - $\leq 20/h$  for a switching frequency of 1 min. between switching on/off via mains voltage.
  - The electrical connection must be made via a fixed connecting cable equipped with a connector device or an all-pole switch with a contact opening width of at least 3 mm (VDE 0700/Part 1).
  - Use a connecting cable with sufficient outer diameter (e.g. H05VV-F3G1.5) to protect against leaking water and to ensure strain relief on the threaded cable connection.
  - Use a heat-resistant connecting cable where fluid temperatures exceed 90 °C.
  - Ensure that the connecting cable does not make contact with either the pipes or the pump.

### **Mains cable connection**

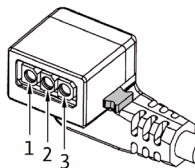

Installing the mains connection cable (Fig. 3):

1. Standard: 3-core coated cable with brass ferrules
  2. Optional: Mains cable with 3-pin connection plug
  3. Optional: Wilo-Connector cable (Fig. 3, item b)
- Cable assignment:
    - 1 yellow/green: PE (⊖)
    - 2 blue: N
    - 3 brown: L
  - Press down the locking button of the 3-pin pump plug and connect the plug to the plug connection (12) of the control module until it snaps into place (Fig. 4).

**Wilо-Connector** Installing Wilо-Connector**connection**

- Disconnect the connecting cable from the power supply.
- Observe terminal assignment (⊖ (PE), N, L).
- Connect and install the Wilо-Connector (Fig. 5a to 5e).

## Connecting the pump

- Earth the pump.
- Connect the Wilо-Connector to the connection cable until it snaps into place (Fig. 5f).

## Removing the Wilо-Connector

- Disconnect the connecting cable from the power supply.
- Remove the Wilо-Connector using a suitable screwdriver (Fig. 6).

**Connection to an existing device**

The pump can be directly connected to an existing pump cable with a 3-pin plug (e.g. Molex) when being replaced (Fig. 3, item a).

- Disconnect the connecting cable from the power supply.
- Press down the locking button of the installed plug and remove the plug from the control module.
- Observe the terminal assignment (PE, N, L).
- Connect the existing device plug to the plug connection (12) of the control module.

## **iPWM/LIN connection**

Connecting the iPWM/LIN signal cable (accessories)

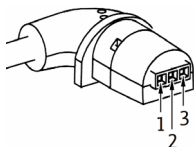

- Connect the signal cable plug to the iPWM/LIN connection (11) until it snaps into place.

### **iPWM:**

- Cable assignment:
  - 1 brown: PWM input (from controller)
  - 2 blue or grey: Signal earth (GND)
  - 3 black: PWM output (from the pump)
- Signal properties:
  - Signal frequency: 100 Hz – 5000 Hz (1000 Hz nominal)
  - Signal amplitude: Min. 3.6 V at 3 mA to 24 V for 7.5 mA, absorbed by the pump interface.
  - Signal polarity: yes

### **LIN:**

- Cable assignment:
  - 1 brown: 12 V DC to 24 V DC (+/-10 %)
  - 2 blue or grey: Signal earth (GND)
  - 3 black: LIN bus data
- Signal properties:
  - Bus speed: 19200 bit/s

---

### **CAUTION!**

The connection of mains voltage (230 V AC) to the communication pins (iPWM/LIN) will destroy the product.

- At the PWM input, the maximum voltage is 24 V pulsed input voltage.
-

## 7 Commissioning

Commissioning only by qualified technicians.

### 7.1 Venting



- Fill and vent the system correctly.

If the pump does not vent automatically:

- Activate the pump venting function via the operating button: press and hold for 3 seconds, then release.
  - ➔ The pump venting function is initiated and lasts 10 minutes.
  - ➔ The top and bottom LED rows flash in turn at 1 second intervals.
- To cancel, press and hold the operating button for 3 seconds.



#### NOTICE

After venting, the LED display shows the previously set values of the pump.

### 7.2 Setting the control mode



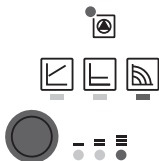















#### Select control mode



The LED selection of control modes and corresponding pump curves takes place in clockwise succession.

- Press the operating button briefly (approx. 1 second).
  - ➔ LEDs display the set control mode and pump curve.

The following shows the various possible settings (for example: constant speed / characteristic curve III):

	LED display	Control mode	Pump curve
1	 	Constant speed	II
2	 	Constant speed	I
3	 	Variable differential pressure $\Delta p-v$	III
4	 	Variable differential pressure $\Delta p-v$	II
5	 	Variable differential pressure $\Delta p-v$	I
6	 	Constant differential pressure $\Delta p-c$	III
7	 	Constant differential pressure $\Delta p-c$	II
8	 	Constant differential pressure $\Delta p-c$	I
9	 	Constant speed	III

- Pressing the button for the 9th time returns to the basic setting (constant speed / characteristic curve III).

### Lock/unlock the button



- To activate the key lock, press and hold the operating button for 8 seconds until the LEDs for the selected setting briefly flash, then release.
  - ↳ LEDs flash constantly at 1-second intervals.
  - ↳ The key lock is activated: pump settings can no longer be changed.
- The key lock is deactivated in the same manner as it is activated.



#### NOTICE

All settings/displays are retained if the power supply is interrupted.

### Activating factory setting

The factory setting is activated by pressing and holding the operating button whilst switching off the pump.

- Press and hold the operating button for at least 4 seconds.
    - ↳ All LEDs flash for 1 second.
    - ↳ The LEDs for the last setting flash for 1 second.
- When the pump is switched on again, the pump runs using the factory settings (delivery condition).

## 8 Decommissioning

### Shutting down the pump

Shut down the pump immediately if the connecting cable or other electrical components are damaged.

- Disconnect the pump from the power supply.
- Contact Wilo customer service or a specialist technician.

## 9 Maintenance

### Cleaning

- Carefully remove dirt from the pump on a regular basis using a dry duster.
- Never use liquids or aggressive cleaning agents.

## 10 Faults, causes and remedies

The troubleshooting must only be carried out by a qualified specialist, and work on the electrical connection must only be carried out by a qualified electrician.

Faults	Causes	Remedy
Pump is not running although the power supply is switched on	Electrical fuse defective	Check fuses
	No voltage supply at pump	Rectify the power interruption
Noisy pump	Cavitation due to insufficient suction pressure	Increase the system pressure within the permissible range
		Check the delivery head and set it to a lower head if necessary
Building does not warm up	Thermal output of the heating surfaces is too low	Increase setpoint
		Change the control mode from $\Delta p$ -c to $\Delta p$ -v

## 10.1 Fault signals

- The fault signal LED indicates a fault.
- The pump switches off (depending on the fault) and attempts a cyclical restart.

LED	Faults	Causes	Remedy
Lights up red	Blocking	Rotor blocked	Activate manual restart or contact customer service
	Contacting/ winding	Winding defective	
Flashes red	Under/overvoltage	Power supply too low/high on mains side	Check mains voltage and operating conditions, and request customer service
	Excessive module temperature	Module interior too warm	
	Short-circuit	Motor current too high	
Flashes red/ green	Generator operation	Water is flowing through the pump hydraulics, but there is no mains voltage at the pump	Check the mains voltage, water quantity/pressure and the ambient conditions
	Dry run	Air in the pump	
	Overload	Sluggish motor, pump is operated outside of its specifications (e.g. high module temperature). The speed is lower than during normal operation	



## Manual restart



- The pump attempts an automatic restart upon detecting a blockage.

If the pump does not restart automatically:

- Activate manual restart via the operating button: press and hold for 5 seconds, then release.
  - ↳ The restart function is initiated, and lasts max. 10 minutes.
  - ↳ The LEDs flash in succession clockwise.
- To cancel, press and hold the operating button for 5 seconds.



### NOTICE

After the restart, the LED display shows the previously set values of the pump.

**If the fault cannot be remedied, contact a specialist technician or Wilo customer service.**

## 11 Disposal

### Information on the collection of used electrical and electronic products

Proper disposal and appropriate recycling of this product prevents damage to the environment and danger to your personal health.

---



#### NOTICE

#### Disposal in domestic waste is forbidden!

In the European Union, this symbol can appear on the product, the packaging or the accompanying documentation. It means that the electrical and electronic products in question must not be disposed of along with domestic waste.

---

To ensure proper handling, recycling and disposal of the used products in question, please note the following points:

- Only hand over these products at designated, certified collecting points.
- Observe the locally applicable regulations!

Please consult your local municipality, the nearest waste disposal site, or the dealer who sold the product to you for information on proper disposal. Further recycling information at [www.wilo-recycling.com](http://www.wilo-recycling.com)

**EU/EG KONFORMITÄTSERKLÄRUNG  
DECLARATION DE CONFORMITE UE/CE  
EU/EC DECLARATION OF CONFORMITY**

Als Hersteller erklären wir unter unserer alleinigen Verantwortung, daß die Nassläufer-Umwälzpumpen der Baureihen,  
*Nous, fabricant, déclarons sous notre seule responsabilité que les types de circulateurs des séries,*  
*We, the manufacturer, declare under our sole responsibility that these glandless circulating pump types of the*  
*series,*

**Para AB\*/4-20/\***  
**Para AB\*/6-43/\***  
**Para AB\*/7-50/\***  
**Para AB\*/8-75/\***

*(Die Seriennummer ist auf dem Typenschild des Produktes angegeben / Le numéro de série est inscrit sur la plaque signalétique du produit / The serial number is marked on the product site plate)*

in der gelieferten Ausführung folgenden einschlägigen Bestimmungen entsprechen:  
*dans leur état de livraison sont conformes aux dispositions des directives suivantes :*  
*In their delivered state comply with the following relevant directives:*

- \_ Niederspannungsrichtlinie 2014/35/EU**
- \_ Basse tension 2014/35/UE**
- \_ Low voltage 2014/35/EU**
  
- \_ Elektromagnetische Verträglichkeit - Richtlinie 2014/30/EU**
- \_ Compatibilité électromagnétique 2014/30/UE**
- \_ Electromagnetic compatibility 2014/30/EU**
  
- \_ Energieverbrauchsrelevanter Produkte - Richtlinie 2009/125/EG**
- \_ Produits liés à l'énergie 2009/125/CE**
- \_ Energy-related products 2009/125/EC**

*Nach den Ökodesign-Anforderungen der Verordnung 641/2009 für Nassläufer-Umwälzpumpen, die durch die Verordnung 622/2012 geändert wird  
suivant les exigences d'éco-conception du règlement 641/2009 pour les circulateurs, amendé par le règlement 622/2012*

*This applies according to eco-design requirements of the regulation 641/2009 for glandless circulators amended by the regulation 622/2012*

und entsprechender nationaler Gesetzgebung,  
*et aux législations nationales les transposant,*  
*and with the relevant national legislation,*

sowie auch den Bestimmungen zu folgenden harmonisierten europäischen Normen:  
*sont également conformes aux dispositions des normes européennes harmonisées suivantes :*  
*comply also with the following relevant harmonised European standards:*

**EN 60335-2-51**

**EN 16297-1**  
**EN 16297-3**

**EN 61000-6-1:2007**  
**EN 61000-6-2:2005**

**EN 61000-6-3+A1:2011**  
**EN 61000-6-4+A1:2011**

Aubigny-sur-Nère, 11/10/2017

  
**S.BORDIER**  
**Quality Manager**

N°4224933.01 (CE-A-S n°4530300)

**wilo**

**WILO INTEC**  
**50 Av. Eugène CASELLA**  
**18700 AUBIGNY SUR NERE**  
**France**